

戸塚駅前地区中央土地区画整理事業

町名	地番	ページ
地区全体図		4
戸塚区戸塚町	6001 -1	5
	6001 -2	5
	6001 -3	5
	6001 -4	5
	6001 -5	5
	6001 -6	5
	6001 -7	5
	6001 -8	5
	6001 -9	5
	6001 -10	5
	6001 -11	5
	6000 -10	6
	6000 -13	6
	6002 -1	6
	6002 -2	6, 7
	6002 -3	6, 7
	6002 -4	6, 7
	6002 -5	6, 7
	6002 -6	6, 7
	6002 -7	6, 7
	6002 -8	6, 7
	6002 -9	6, 7
	6002 -10	6, 7
	6002 -11	6, 7
	6002 -12	6, 7
	6002 -13	6, 7
	6002 -14	6, 7
	6002 -15	6, 7
	6002 -16	6, 7
	6002 -17	6, 7

町名	地番	ページ
戸塚区戸塚町	6002 -18	6, 7
	6002 -19	6, 7
	6002 -20	6, 7
	6002 -21	6
	6002 -22	6
	6002 -23	6
	6002 -24	6
	6002 -25	6
	6002 -26	6
	6002 -27	6
	6002 -28	6
	6002 -29	6
	6002 -30	6
	6002 -31	6
	6002 -32	6
	6002 -33	6
	6002 -34	6
	6002 -35	6
	6002 -36	6
	6002 -37	6
	6002 -38	6
	6002 -39	6
	6002 -40	6
	6002 -41	6
	6002 -42	6
	6003 -1	8
	6003 -2	8
	6003 -3	8
	6003 -4	8
	6003 -5	8

町名	地番	ページ
戸塚区戸塚町	6003 -6	8
	6003 -7	8
	6003 -8	8
	6003 -9	8
	6005 -1	9
	6005 -2	9
	6005 -3	9
	6005 -4	9
	6005 -5	9
	6005 -6	9
	6005 -7	9
	6005 -8	9
	6005 -9	9
戸塚区吉田町	3002 -1	10
	3002 -2	10
	3002 -3	10
	3001 -1	11
	3001 -2	11
	3001 -3	11
	3001 -4	11
	3001 -5	11
	3001 -6	11
	3001 -7	11
	3001 -8	11
	3001 -9	11
	3001 -10	11

戸塚駅前地区中央土地区画整理事業

町名	地番	ページ
戸塚区吉田町	3001 -11	11
	3001 -12	11
	3001 -13	11
	3003 -1	12
	3003 -2	12
	3003 -3	12
	3003 -4	12
	3003 -5	12
	3000 -1	13
	3000 -2	13
	3000 -3	13
	3000 -4	13
	3000 -5	13
	3000 -6	13
	3000 -7	13
	3000 -8	13
	3000 -9	13
	3000 -10	13
	3000 -11	13
	3000 -12	13
	3000 -13	13
	3000 -14	13
	3005 -1	14
	3005 -2	14
	3005 -3	14
	3005 -4	14
	3005 -5	14
	3005 -6	14
3005 -7	14	
3005 -8	14	

町名	地番	ページ	
戸塚区吉田町	3005 -9	14	
	3005 -10	14	
	3005 -11	14	
	3005 -12	14	
	3005 -13	14	
	3005 -14	14	
	3005 -15	14	
	3005 -16	14	
	3005 -17	14	
	3005 -18	14	
	3005 -19	14	
	戸塚区戸塚町	6010 -1	15
		6010 -2	15
		6010 -3	15
		6010 -4	15
		6010 -5	15
		6010 -6	15
		6010 -7	15
		6010 -8	15
6010 -9		15	
6010 -10		15	
6010 -11		15	
6010 -12		15	
6010 -13		15	
6010 -14		15	
6010 -15		15	
6010 -16		15	
6010 -17		15	
6010 -18		15	
6010 -19		15	

町名	地番	ページ
戸塚区戸塚町	6010 -20	15
	6010 -21	15
	6010 -22	15
	6011 -1	16
	6011 -2	16
	6011 -3	16
	6011 -4	16
	6012 -1	17
	6012 -2	17
	6012 -3	17
	6012 -4	17
	6012 -5	17
	6013 -1	18
	6013 -2	18
	6013 -3	18
	6013 -4	18
	6013 -5	18
	6013 -6	18
	6013 -7	18
	6013 -8	18
	6013 -9	18
	6013 -10	18
	6013 -11	18
	6013 -12	18
	6013 -13	18
	6013 -14	18
	6013 -15	18
	6013 -16	18
	6013 -17	18

戸塚駅前地区中央土地区画整理事業

町名	地番	ページ
戸塚区戸塚町	6014 -1	19
	6014 -2	19
	6014 -3	19
戸塚区矢部町	3001 -1	20
	3001 -2	20
	3001 -3	20
	3001 -4	20
	3001 -5	20
	3001 -6	20
	3001 -7	20
	3001 -8	20
	3000	21
	3002 -1	21
	3002 -2	21
	3002 -3	21
	3002 -4	21
	3002 -5	21
	3002 -6	21
	3002 -7	21
	3002 -8	21
	3002 -9	21
	3002 -10	21
	3002 -11	21
	3002 -12	21
	3002 -13	21
	3002 -14	21
	3002 -15	21
	3002 -16	21
	3002 -17	21
	3002 -18	21

町名	地番	ページ
戸塚区矢部町	3002 -19	21
	3004 -13	21
	3003 -1	22
	3003 -2	22
	3003 -3	22
	3003 -4	22
	3003 -5	22
	3003 -6	22
	3003 -7	22
	3003 -8	22
	3003 -9	22
	3005 -1	23
	3005 -2	23
	3005 -3	23
	3005 -4	23
	3005 -5	23
	3005 -6	23
	3004 -15	24
	3004 -19	24
	3006 -1	24
	3006 -2	24
	3006 -3	24
	3006 -4	24
	3006 -5	24
	3006 -6	24
	3006 -7	24
	3006 -8	24
	3006 -9	24
3006 -10	24	
3006 -11	24	

町名	地番	ページ
戸塚区矢部町	3006 -12	24
	3006 -13	24
	3006 -14	24
	3006 -15	24
	3006 -16	24
	3006 -17	24
	3006 -18	24
	3007 -1	25
	3007 -2	25
	3007 -3	25
	3007 -4	25
	3007 -5	25
	3007 -6	25
	3004 -22	26
	3008 -1	26
	3008 -2	26
	3008 -3	26
戸塚区戸塚町	6009 -1	27
	6009 -2	27
	6009 -3	27
	6009 -4	27

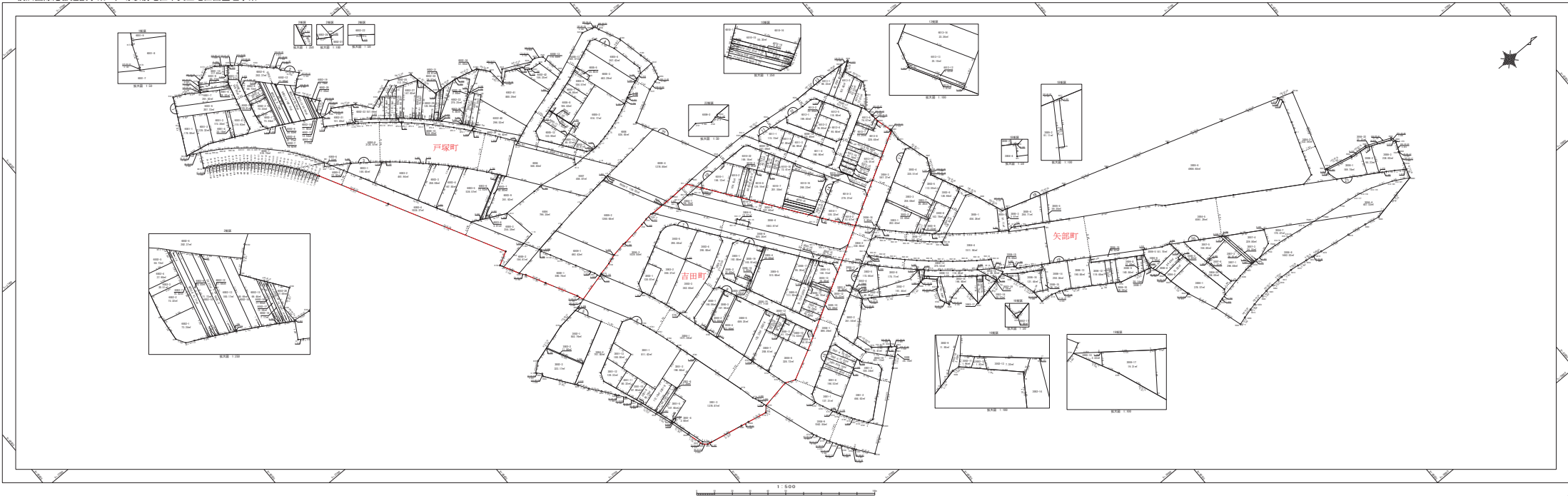

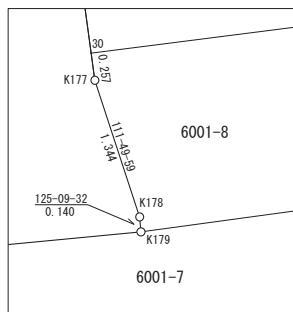
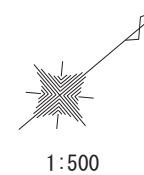

拡大図 1:50

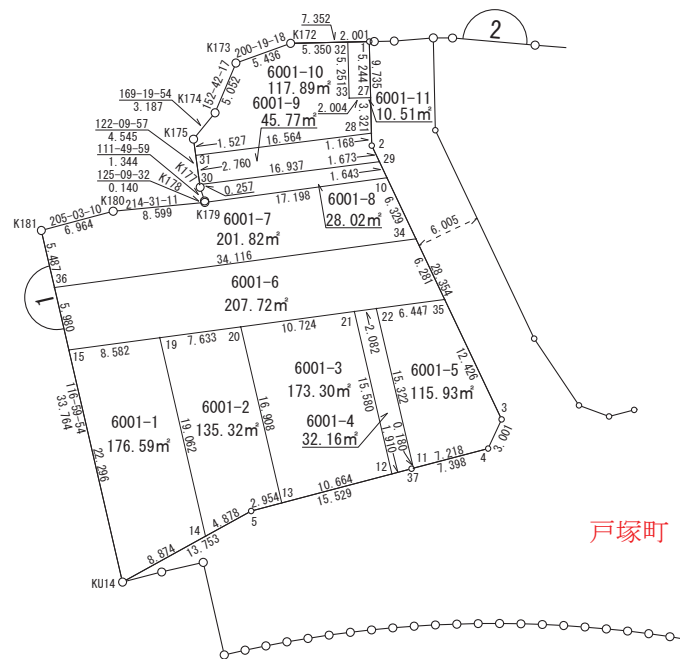

戸塚町

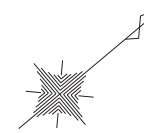

1:500

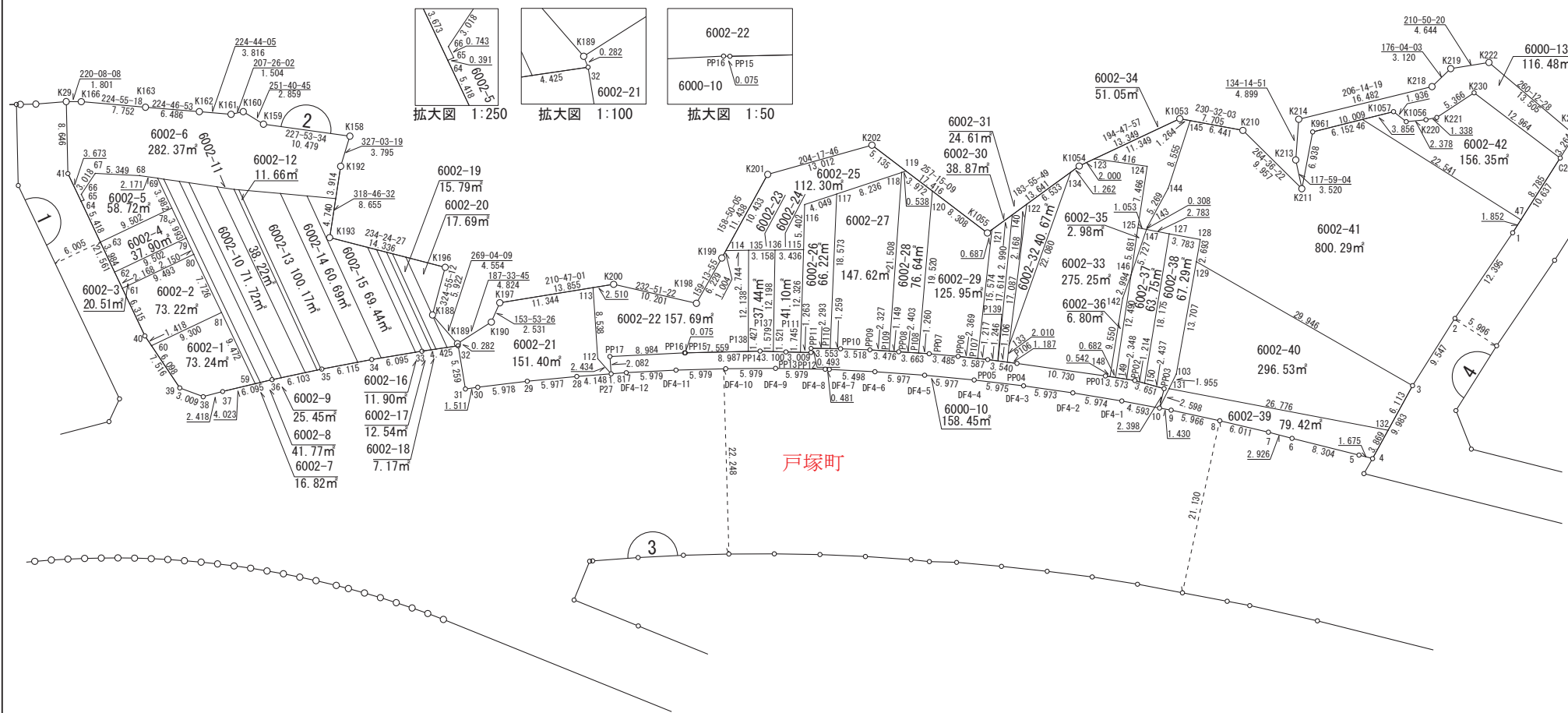

横浜市都市整備局戸塚中央区画整理事務所

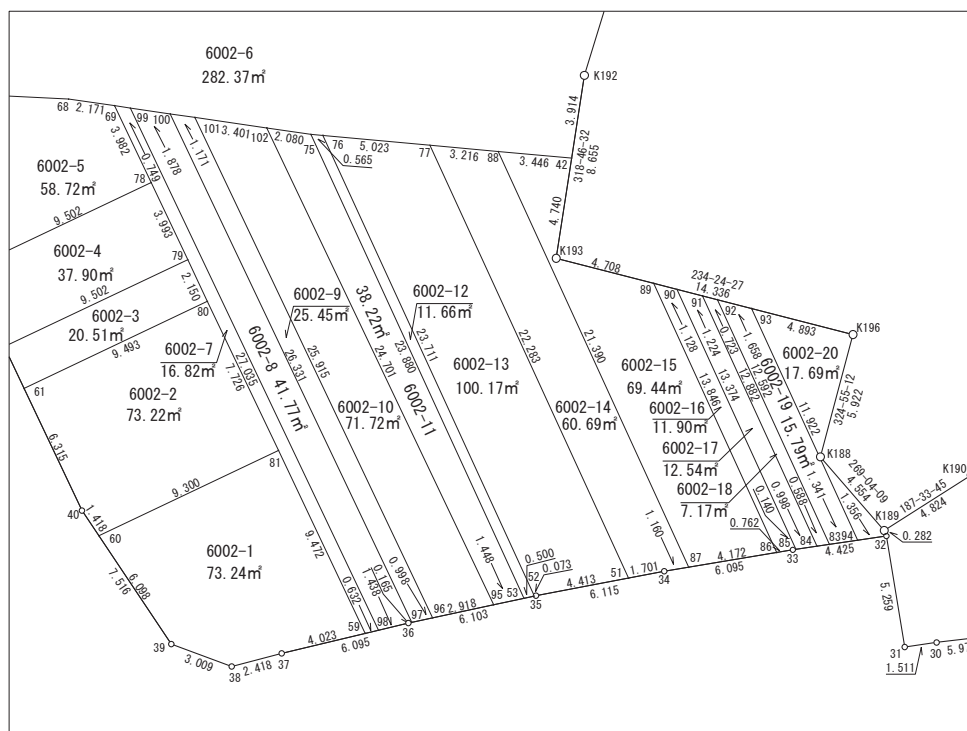

拡大図 1:250

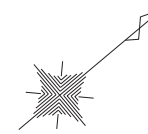

1:500

戸塚町

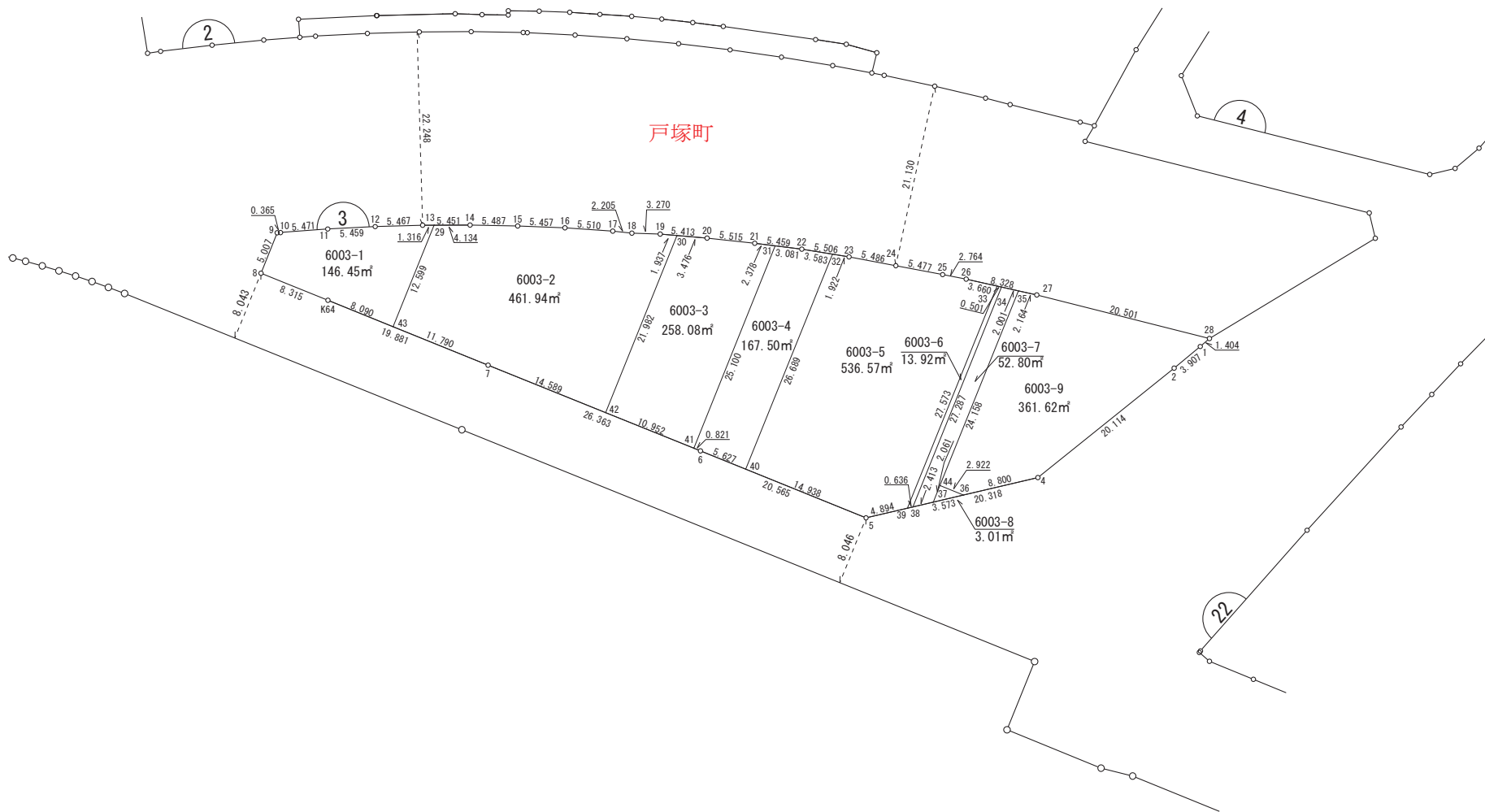

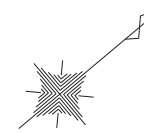

1:500

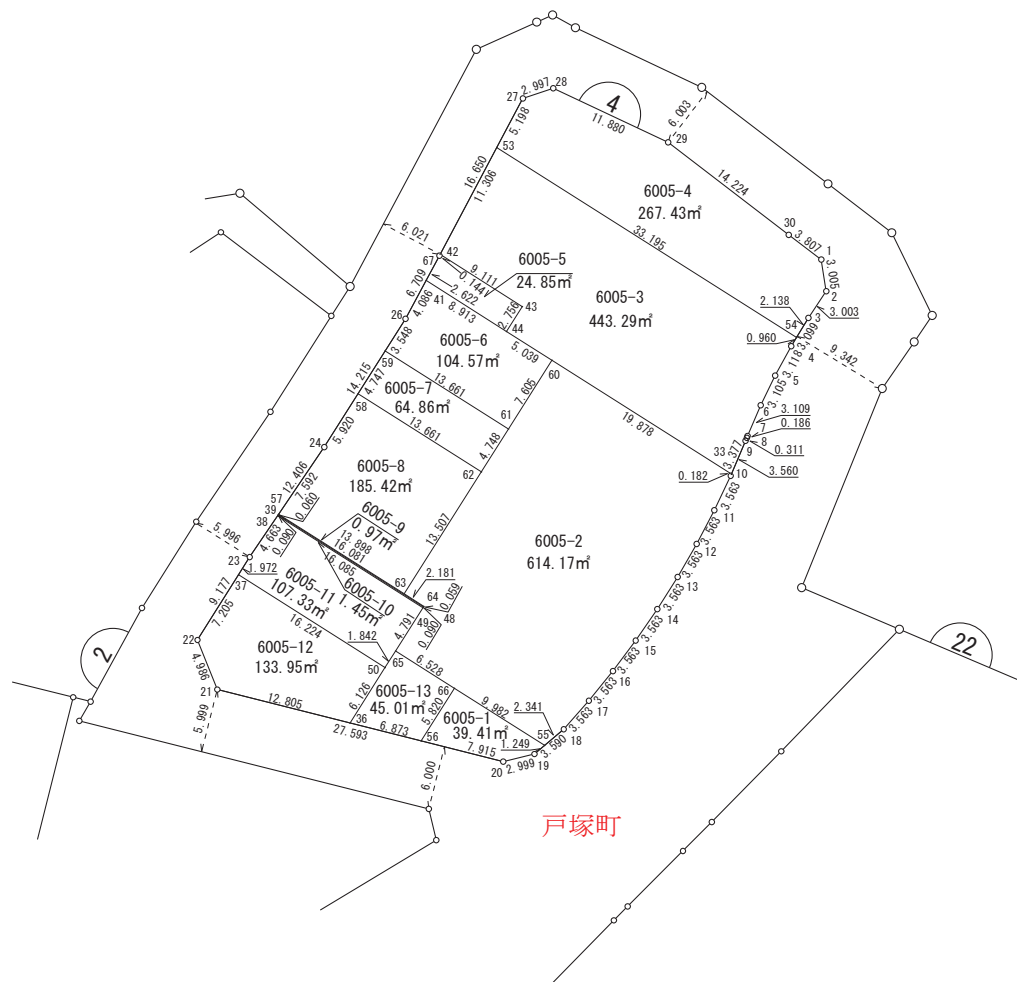

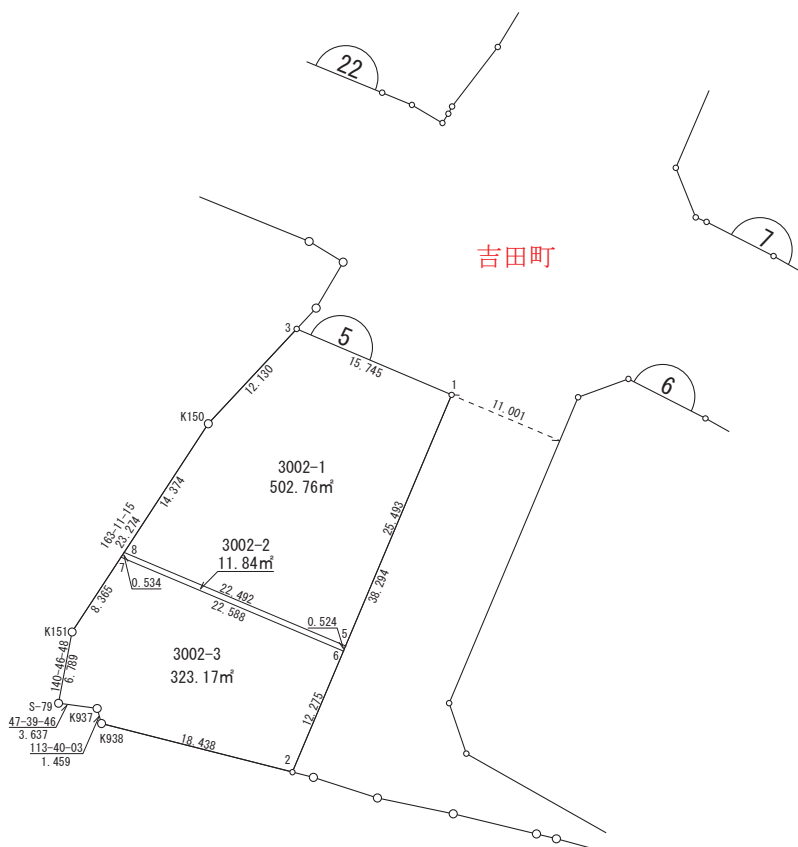
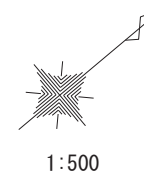

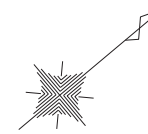

1:500

吉田町



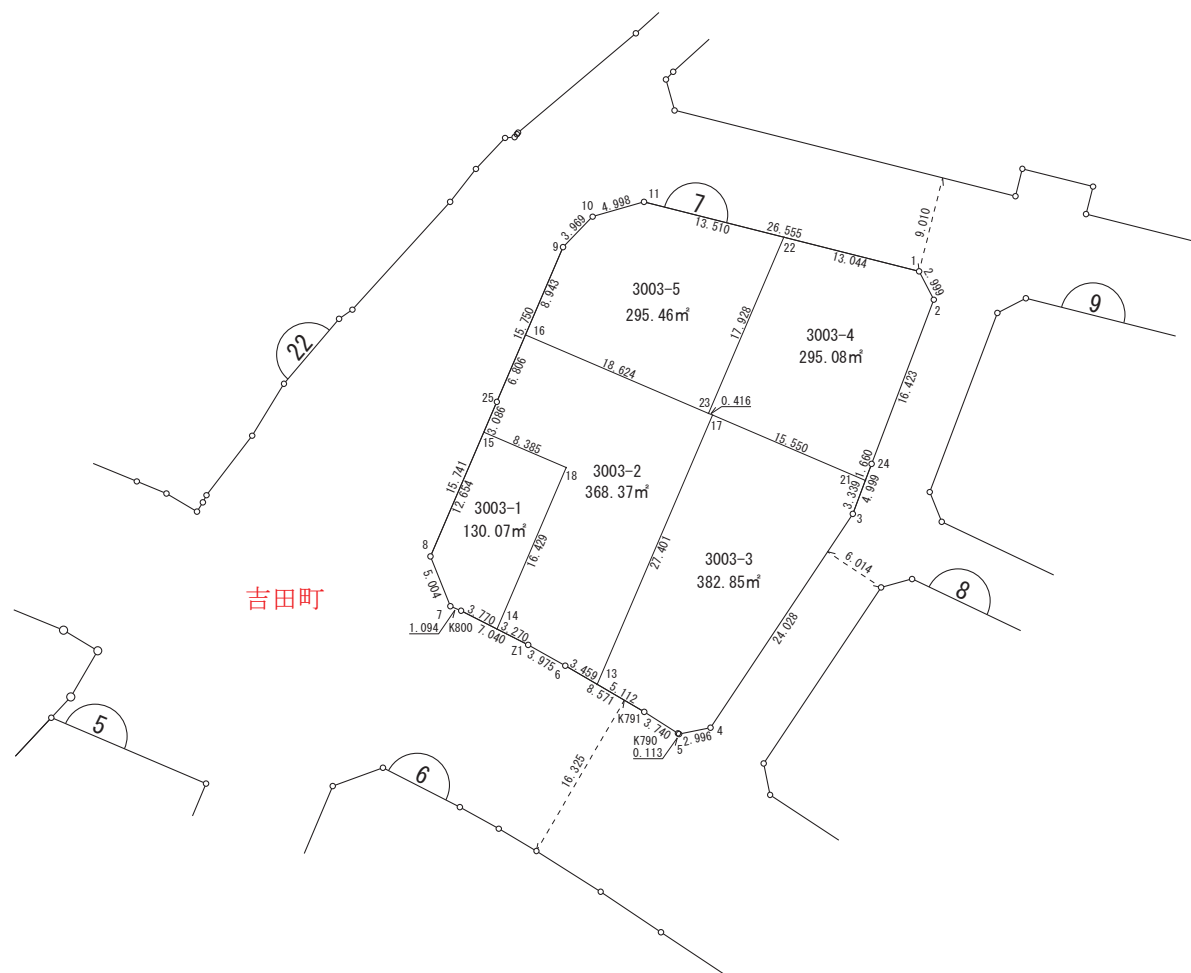
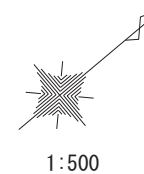

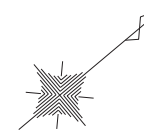

1:500

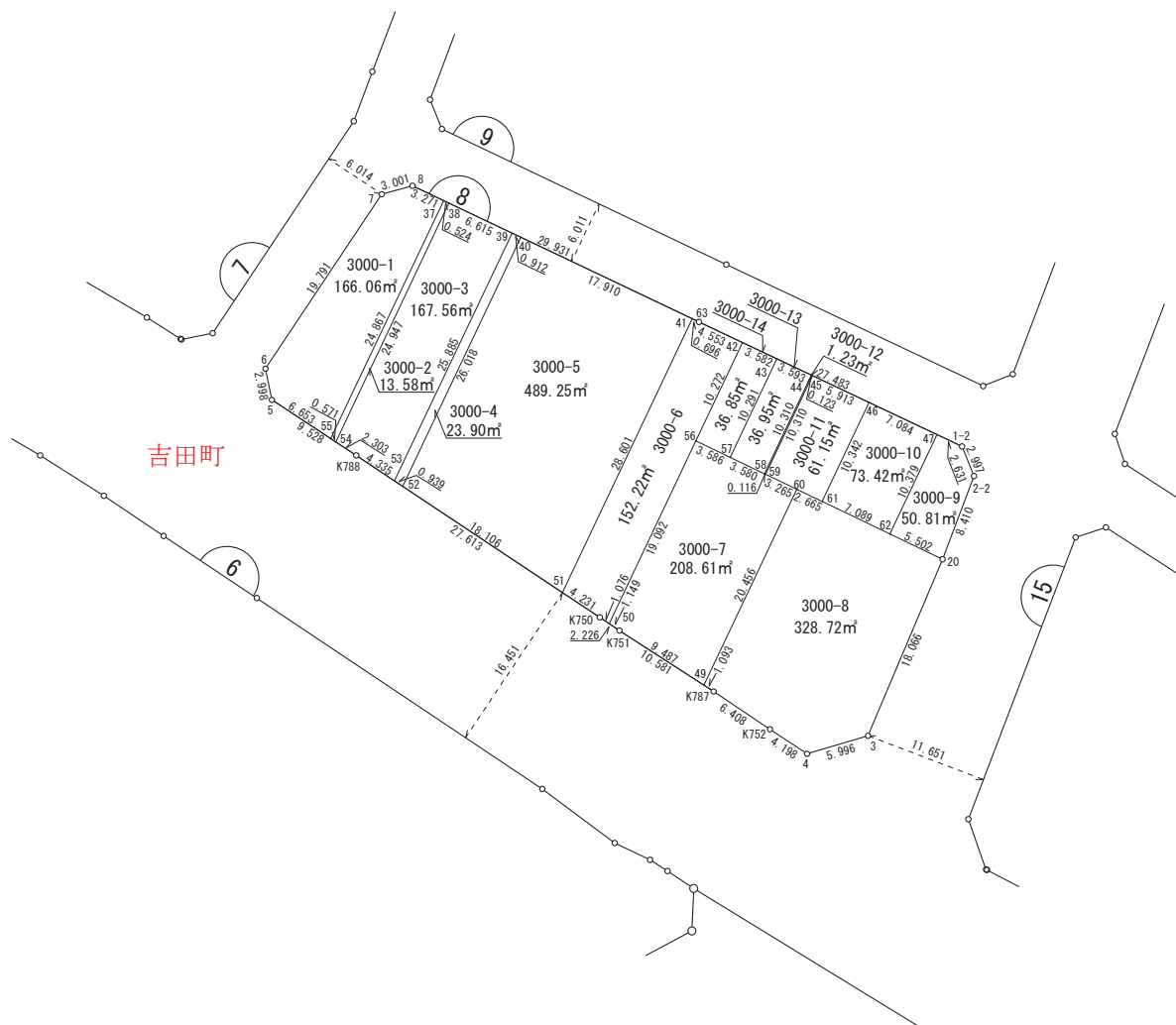

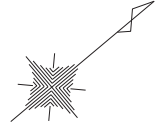

1:500

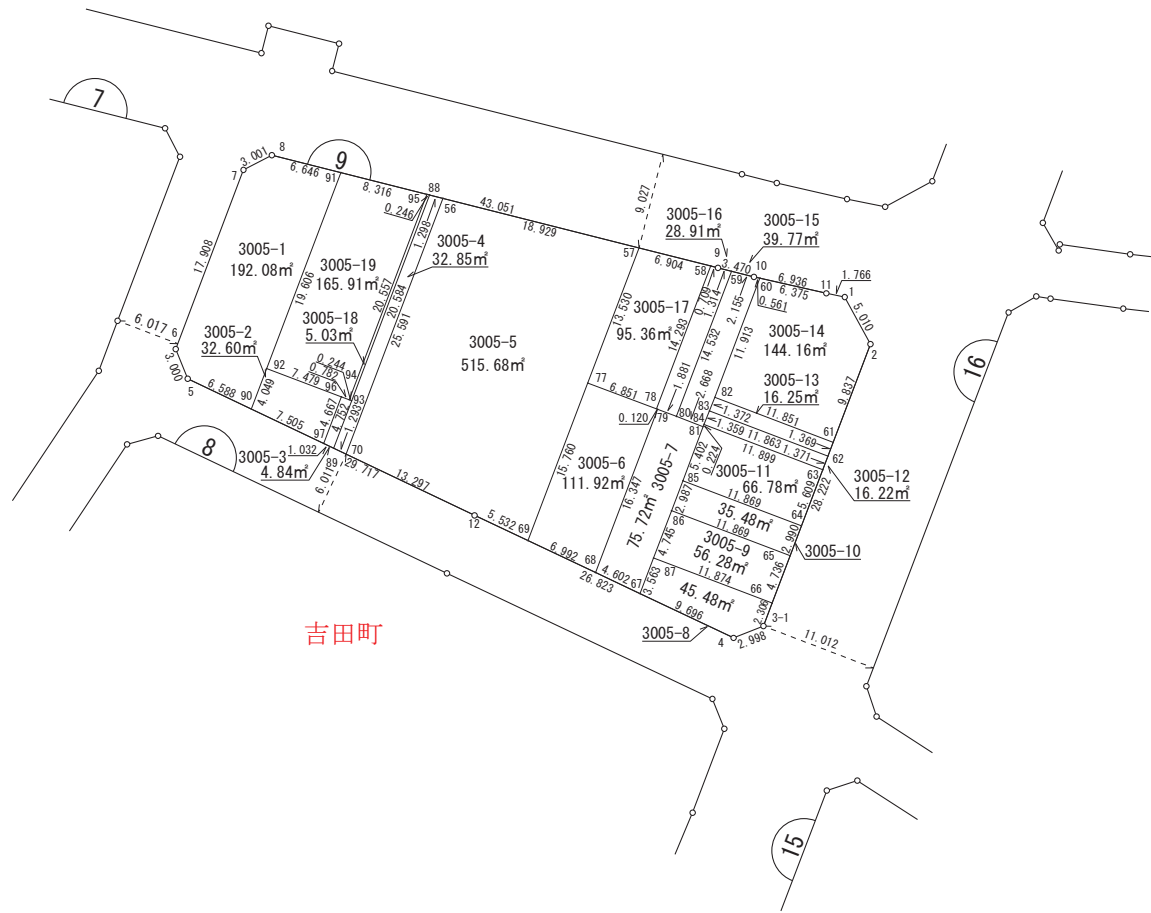

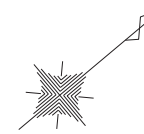

1:500

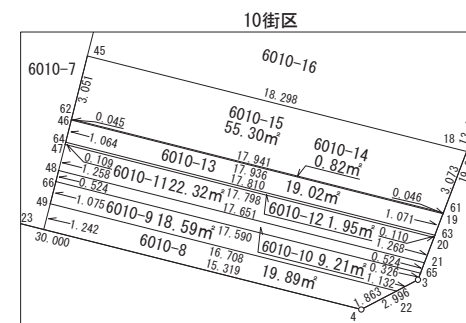
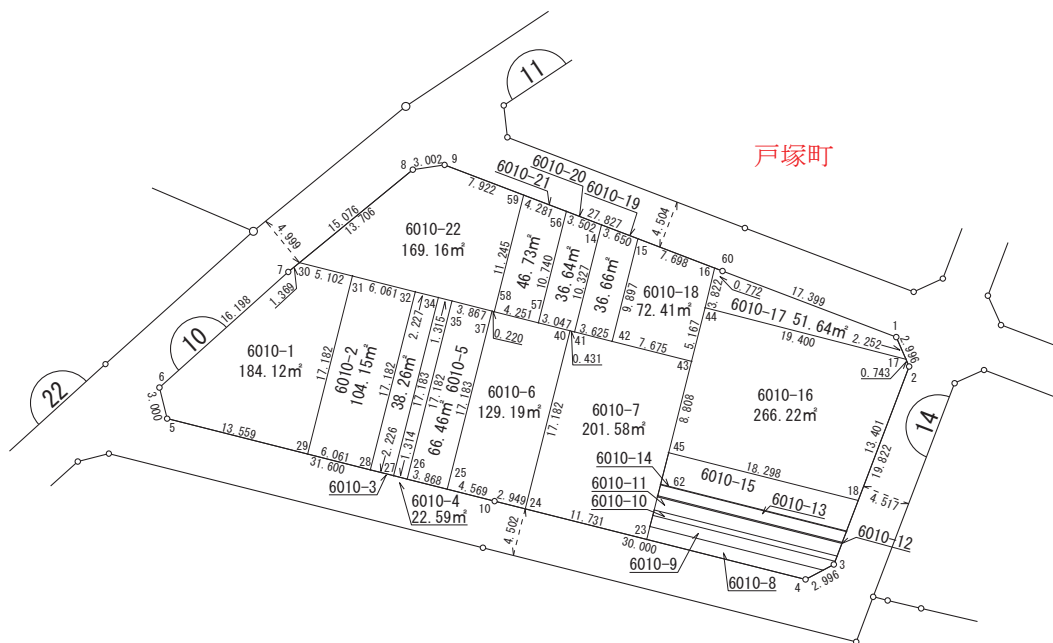

拡大図 1:250

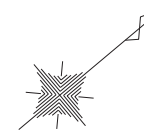

1:500

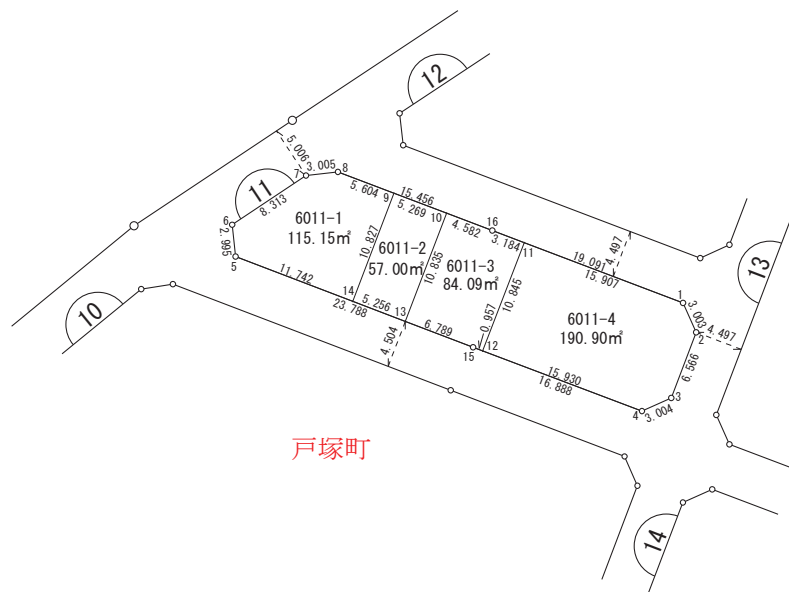

戸塚町

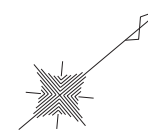

1:500

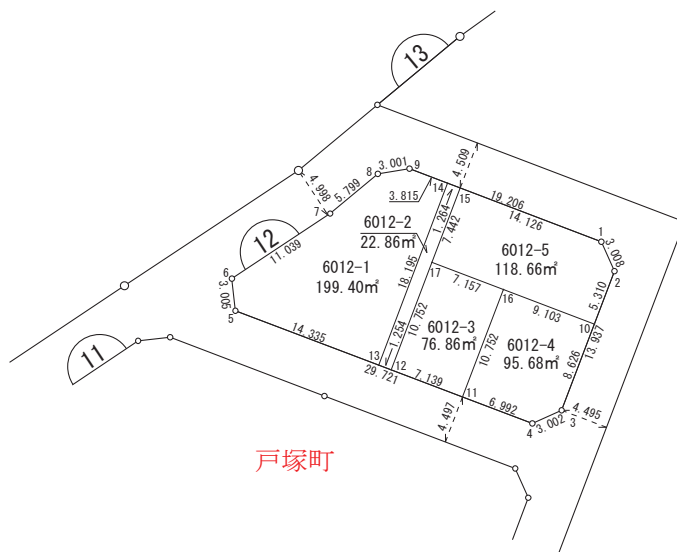

戸塚町

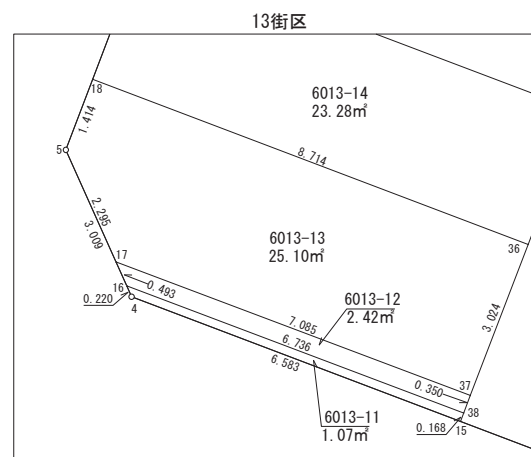
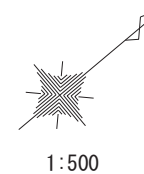

拡大図 1:100

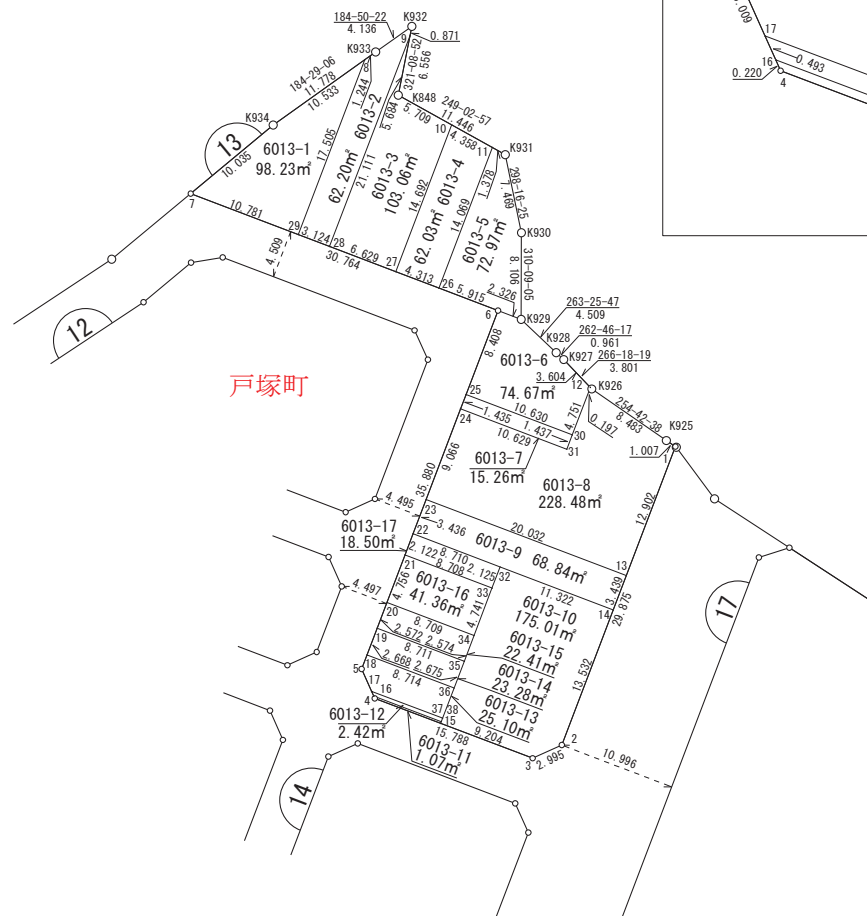

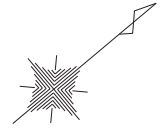

1:500

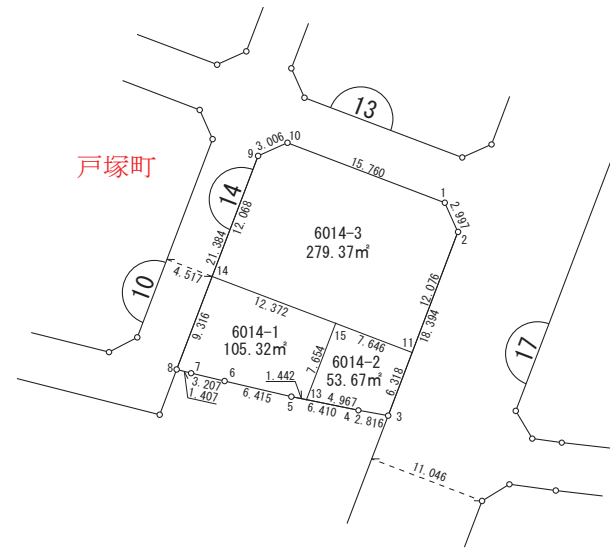

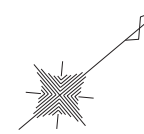

1:500

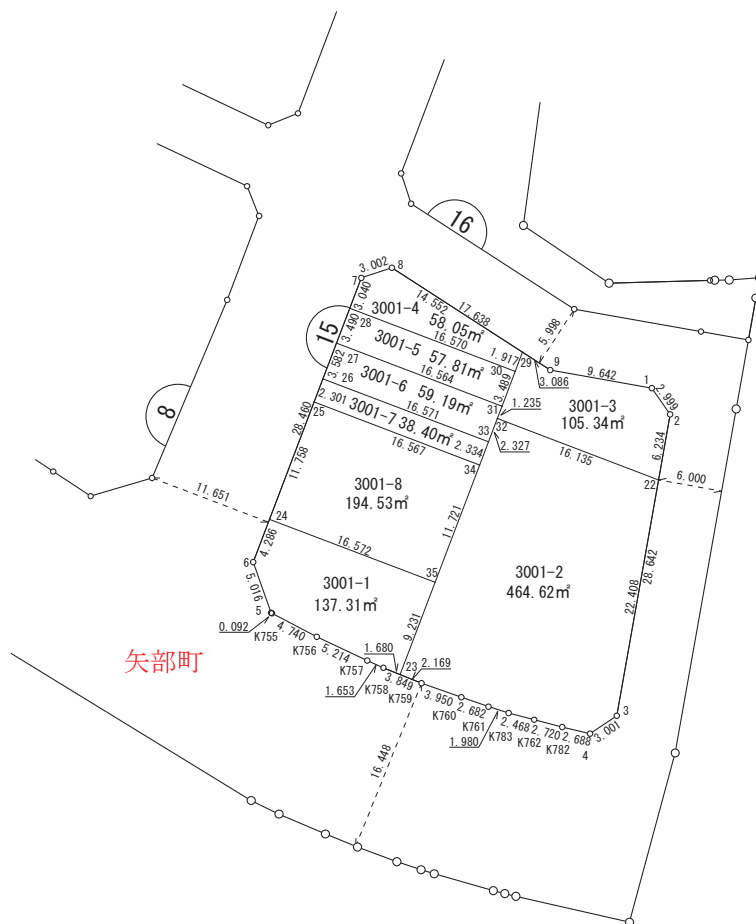

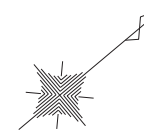

1:500

矢部町

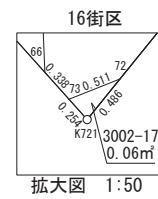
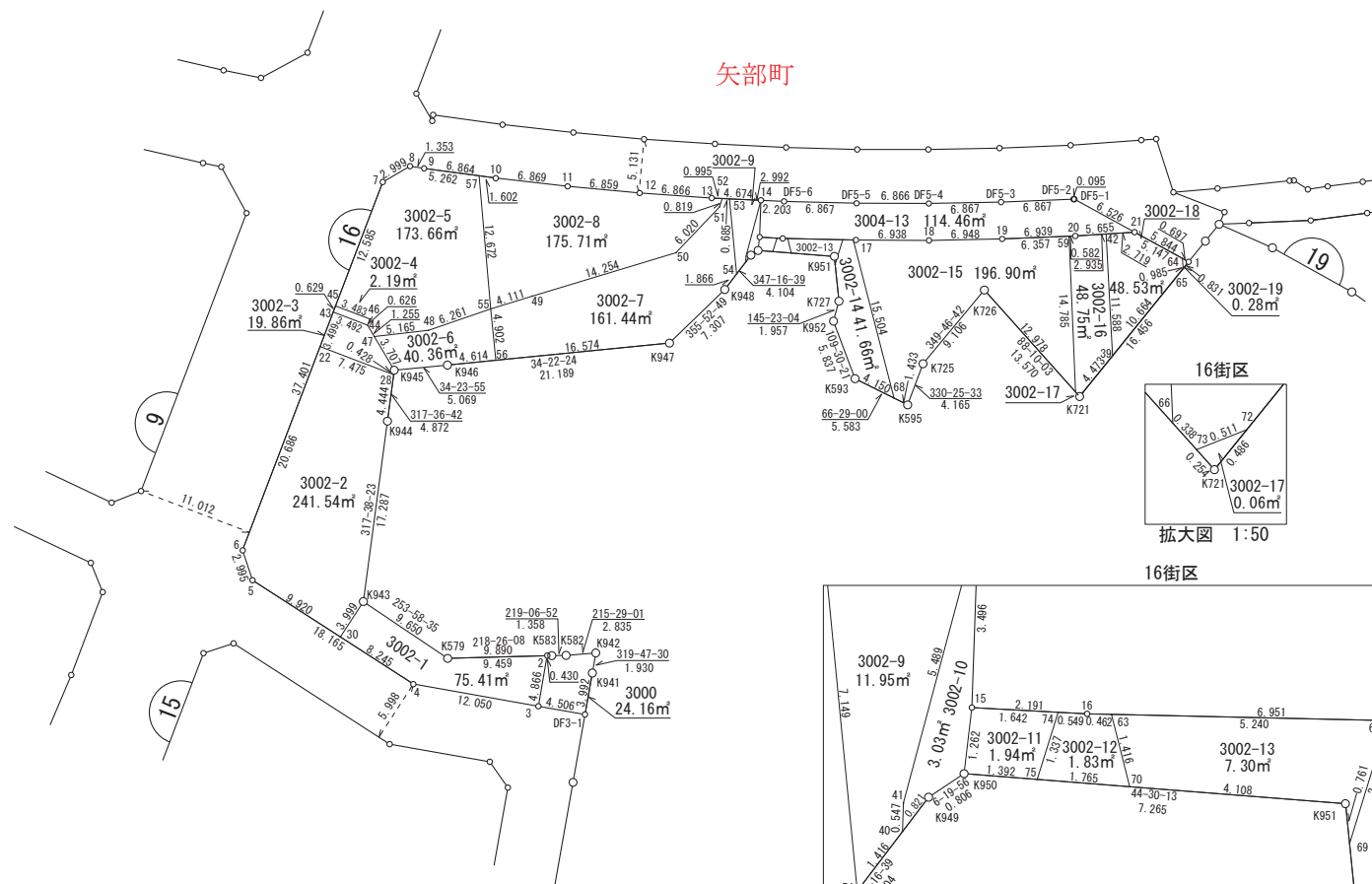

拡大図 1:50

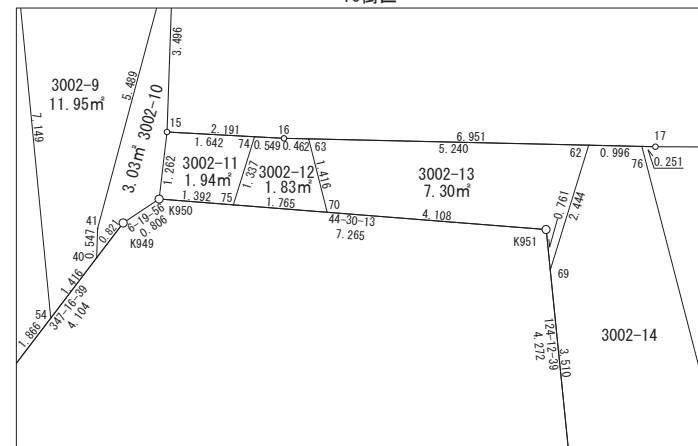

拡大図 1:100

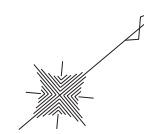

1:500

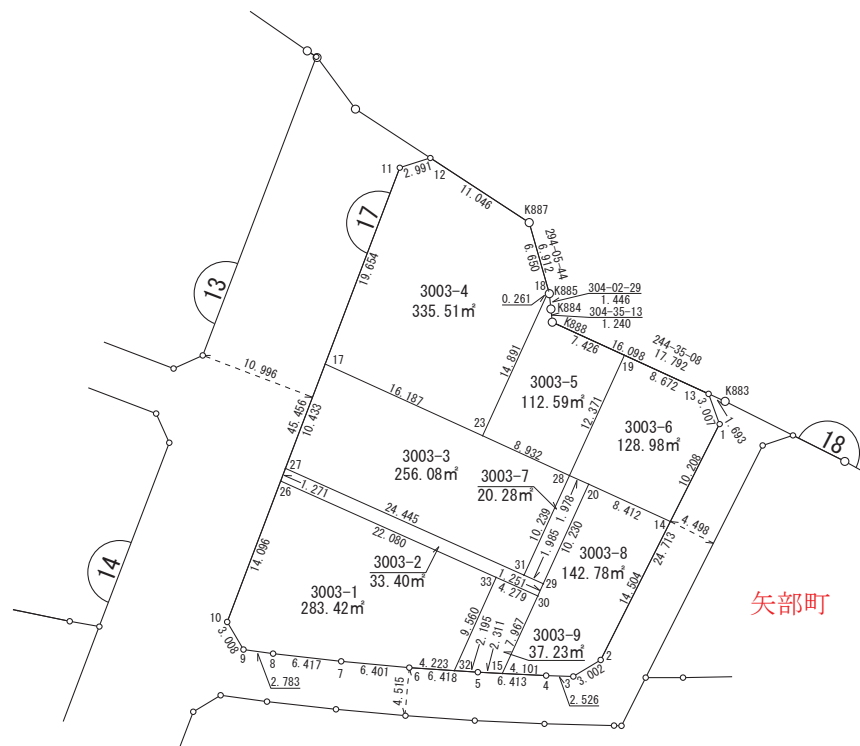

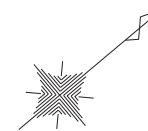

1:600

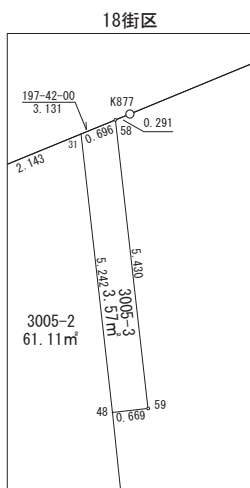

拡大図 1:100



拡大図 1:50

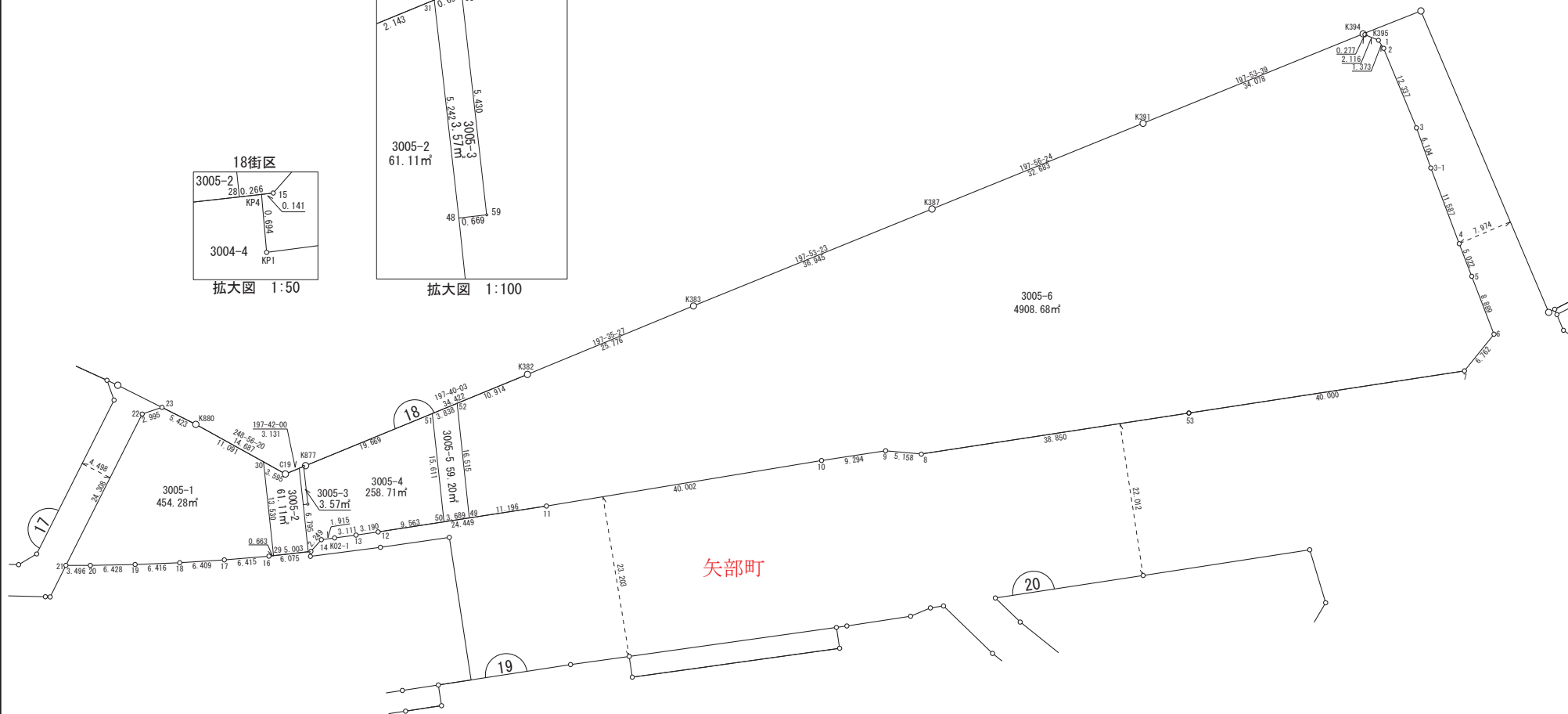

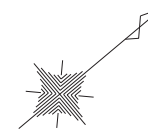

1:500

矢部町



19街区

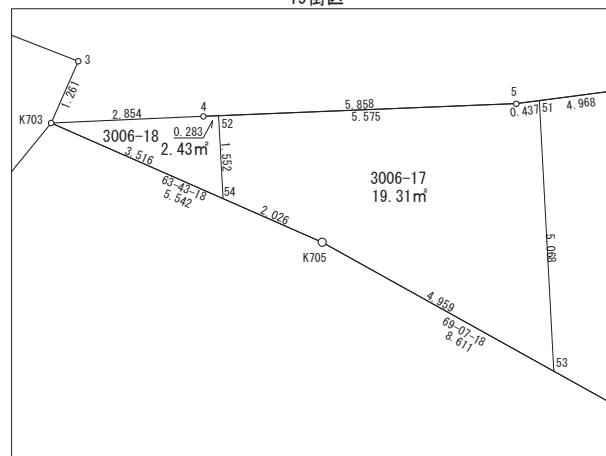

拡大図 1:100

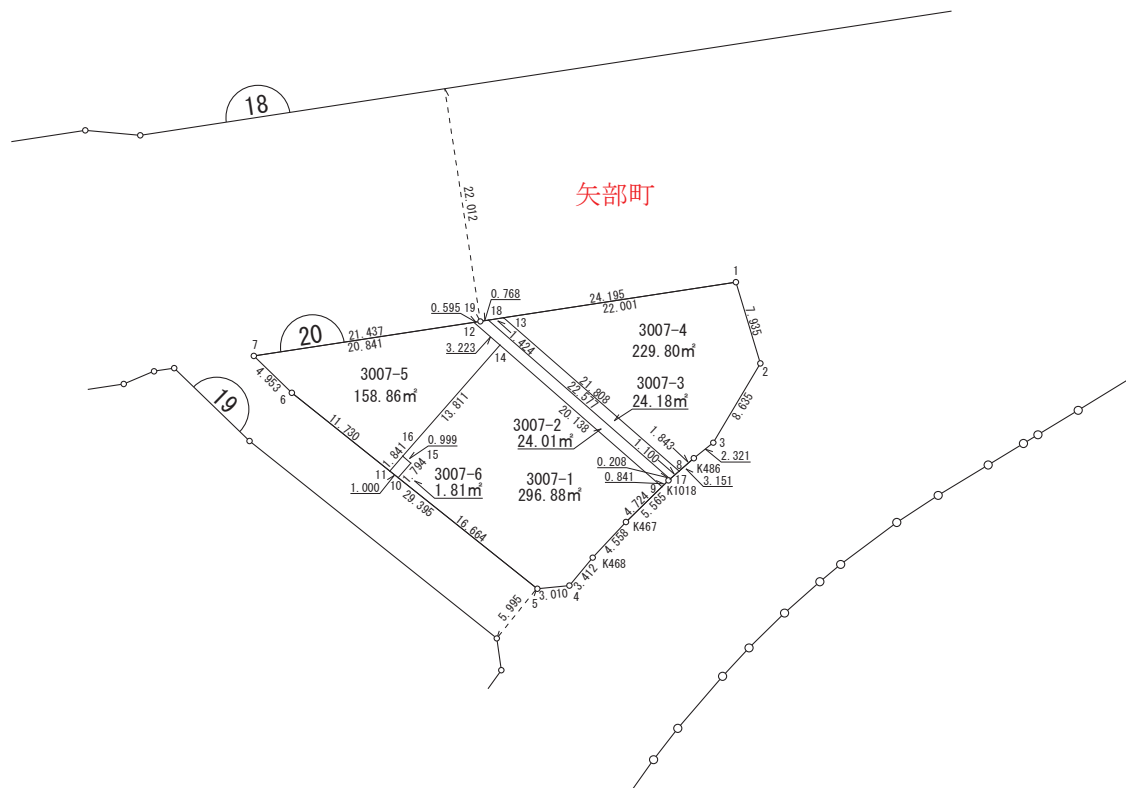
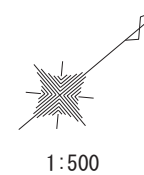

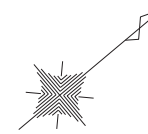

1:500

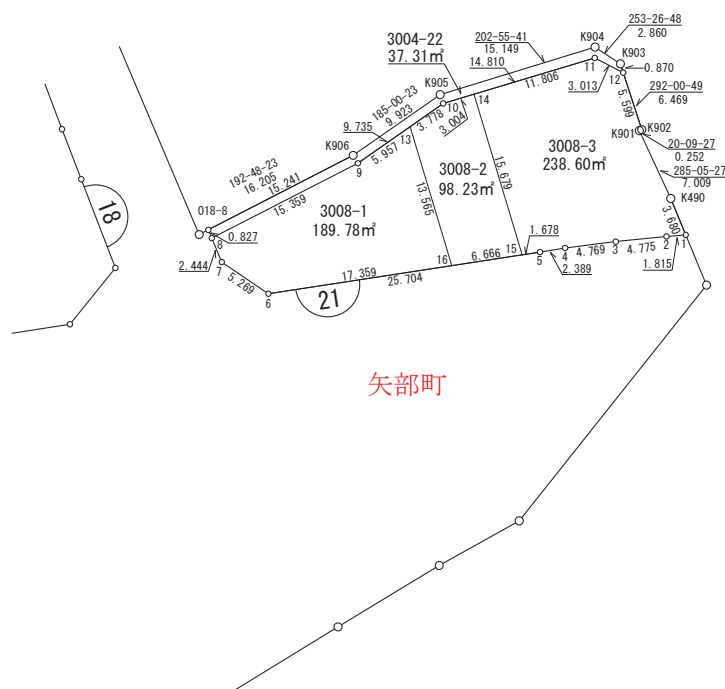

矢部町

