

1 し つ て く へ

1. よみましょう 

1) し つ て く へ

2) へ く し て つ

3) く て し つ て へ く へ

4) へ つ て く し く つ て し へ

2. どれですか

し つ て く へ

へ

し

へ

て

し

て

く

へ

つ

し

3. かきましよう



し つ て く へ
shi tsu te ku he

かきかた

・うえ から した

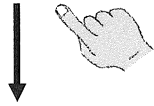

・ひだり から みぎ

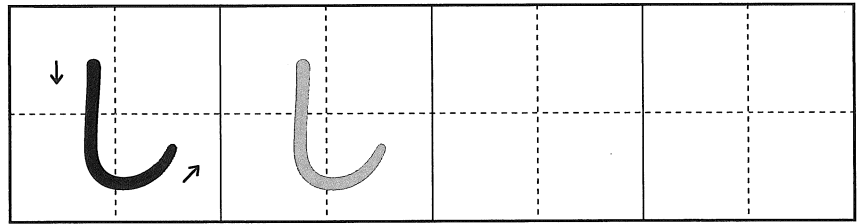
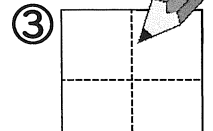
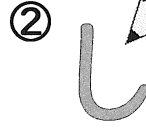
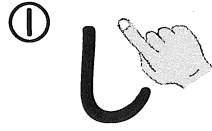
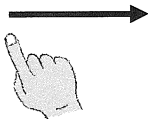

はらう

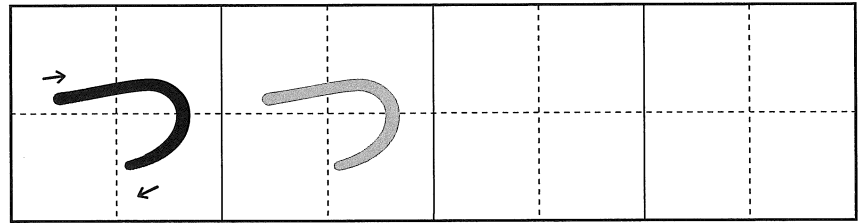
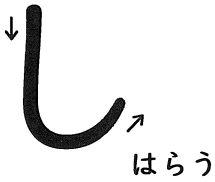

とめる

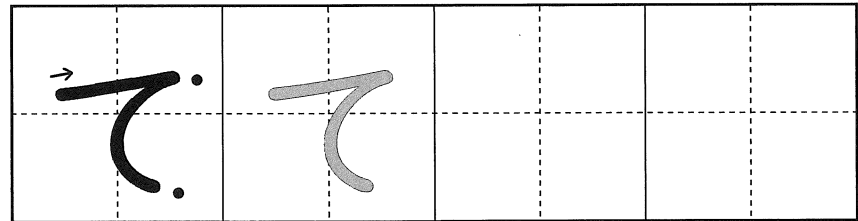
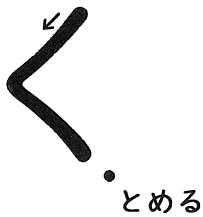

はねる

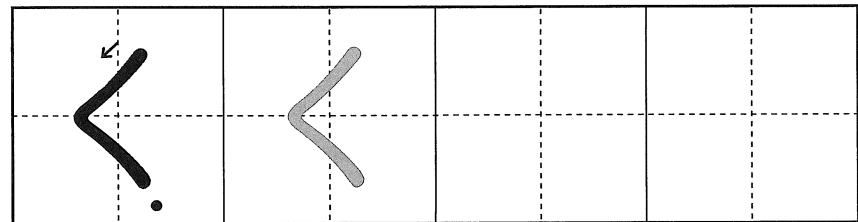
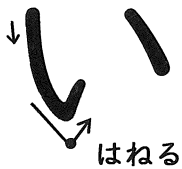

いい

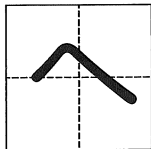
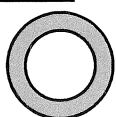

だめ

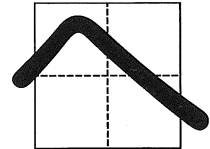
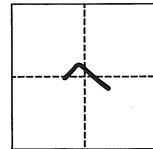
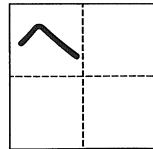

2 あいうえお

1. よみましょう 

1) あ い う え お

2) う あ え お い

3) あ え い う え お あ お

4) お う え あ い あ う え い お

2. よみましょう 

1) あし 

2) いし 

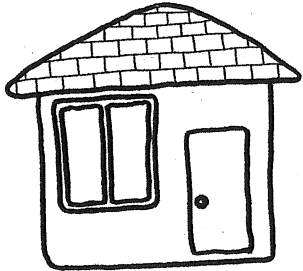
3) いえ 

4) うし 

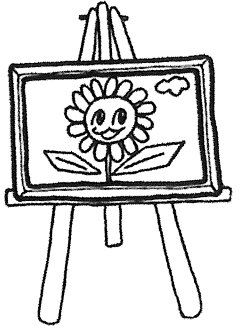
5) え 

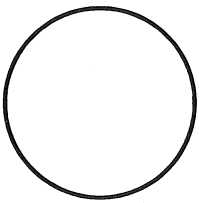
6) あお 
あおでぬりましょう

3. かきましょう

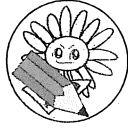

あ

あいうえお

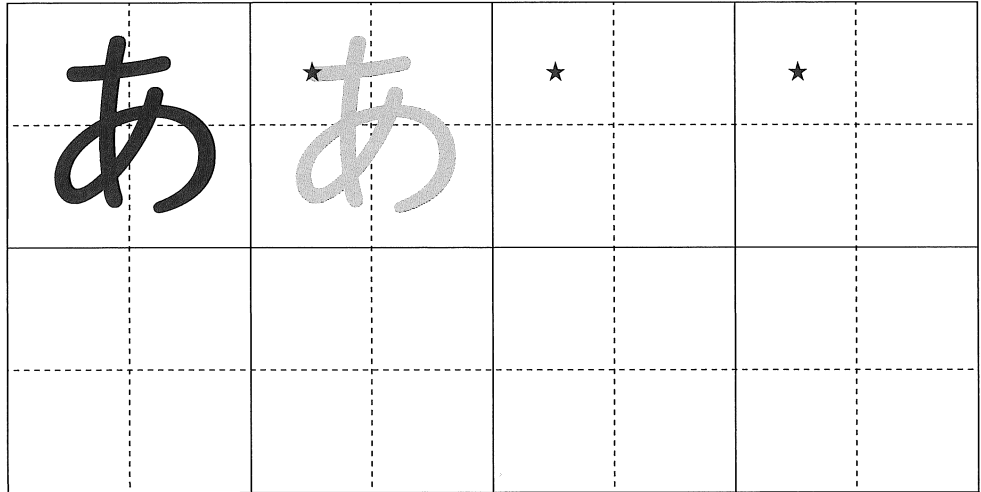
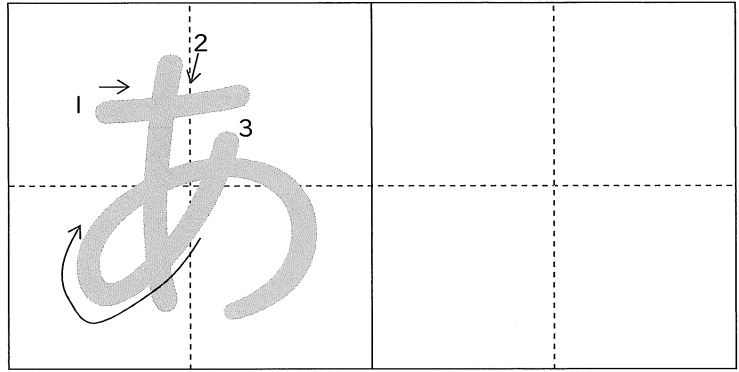

い

あいうえお

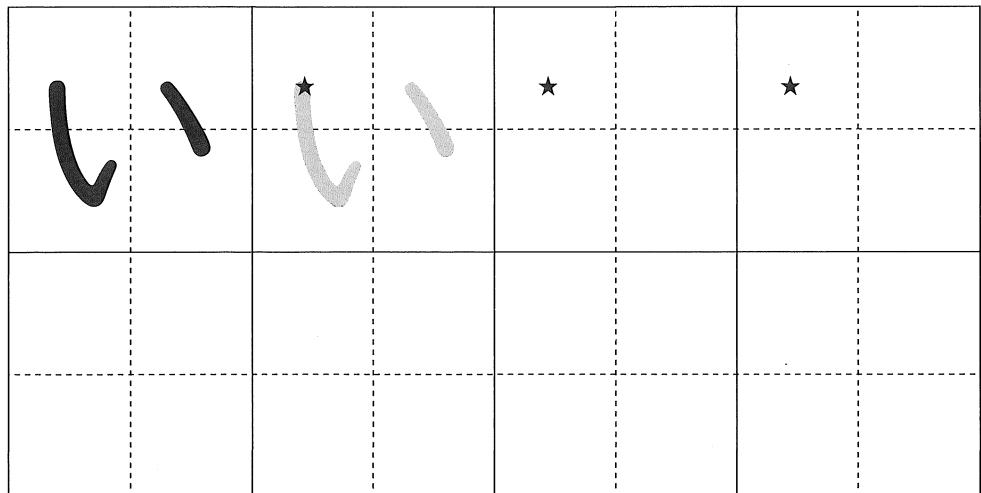
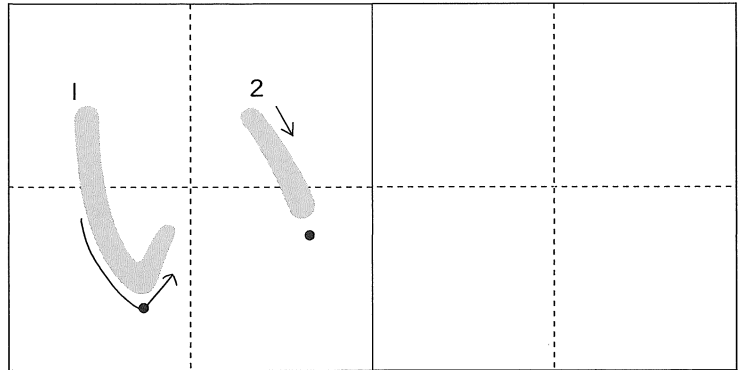

う

あいうえお

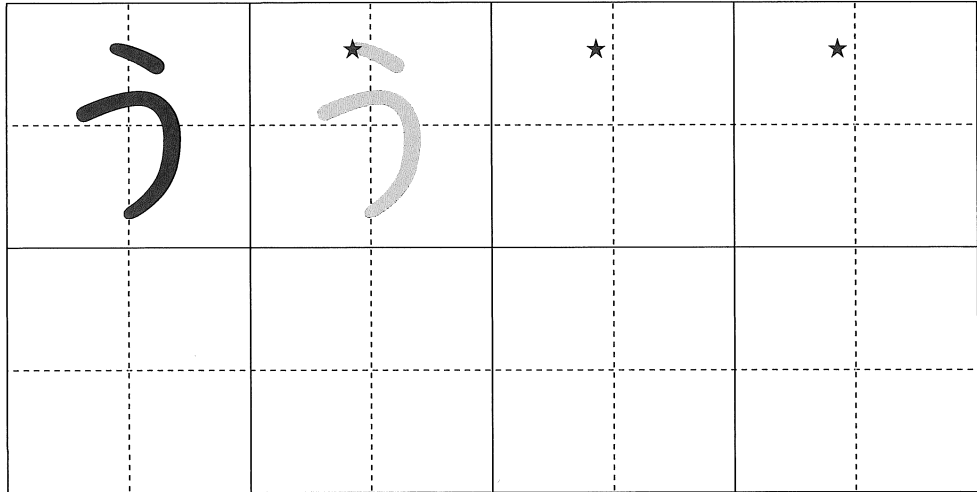
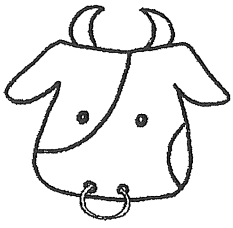
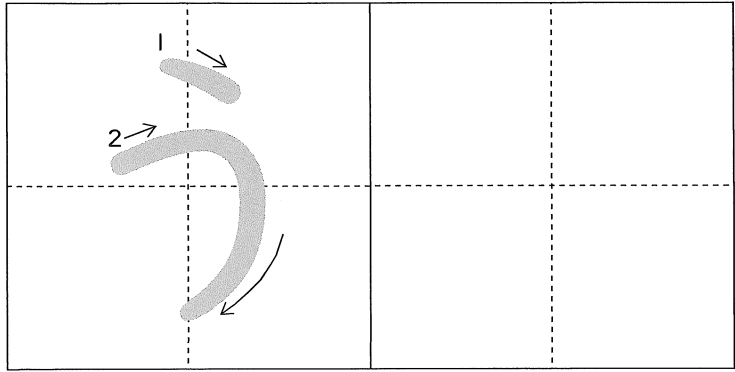

え

あいうえお

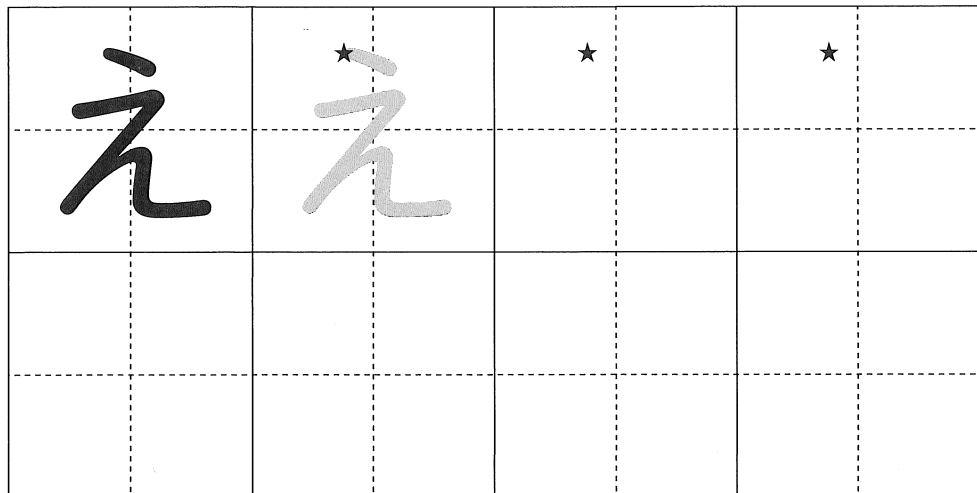
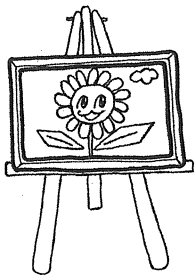
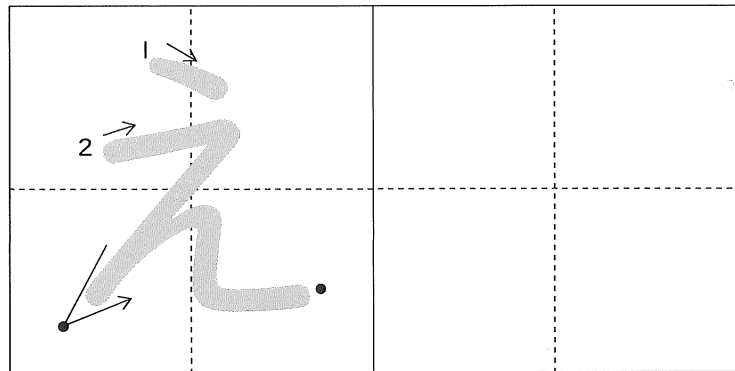

お
あいうえお

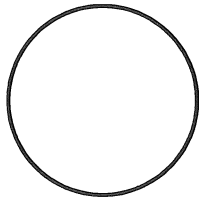
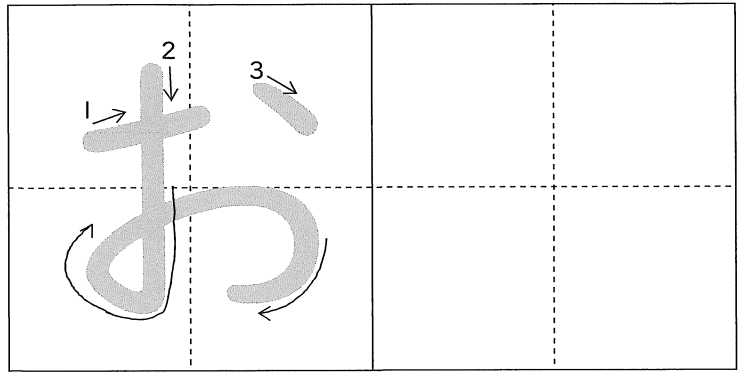

あおでぬりましょう

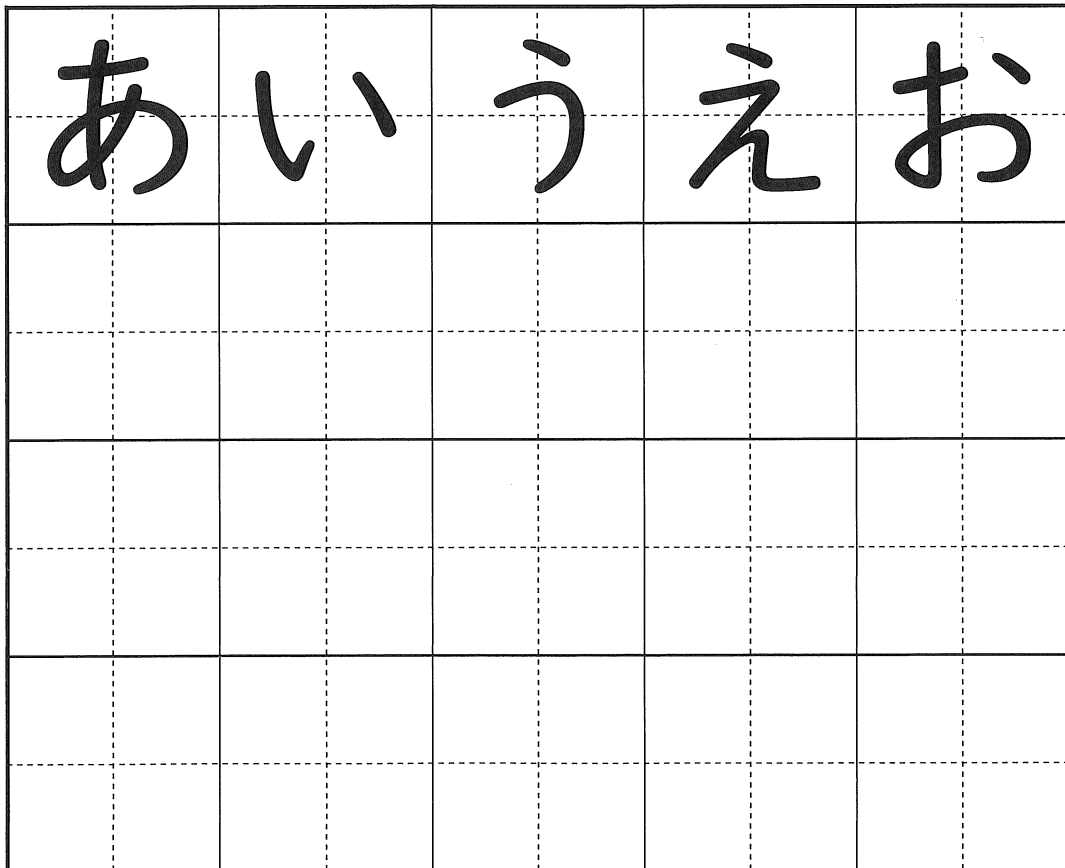
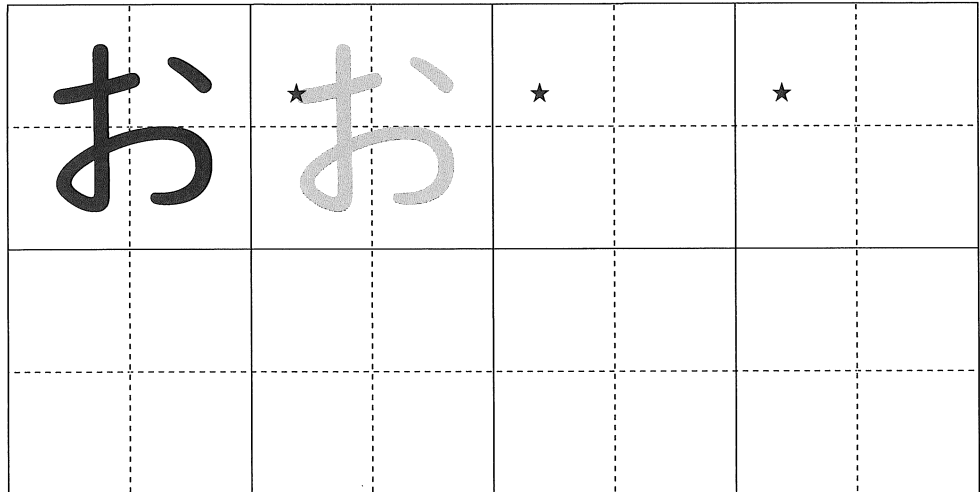

1)



あ
し

| | |
|--|--|
| | |
| | |
| | |
| | |

あ し

| | |
|--|--|
| | |
| | |
| | |
| | |

2)



い
し

| | |
|--|--|
| | |
| | |
| | |
| | |

い し

| | |
|--|--|
| | |
| | |
| | |
| | |

3)



い
え

| | |
|--|--|
| | |
| | |
| | |
| | |

い え

| | |
|--|--|
| | |
| | |
| | |
| | |

4)

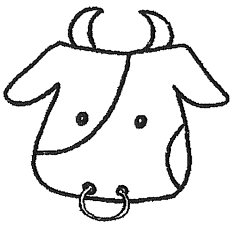

う
し

| | |
|--|--|
| | |
| | |
| | |

う し

| | |
|--|--|
| | |
| | |
| | |

5)

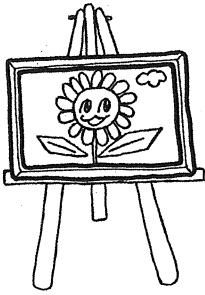

え

| | |
|--|--|
| | |
| | |
| | |

え

| | |
|--|--|
| | |
| | |
| | |

| | |
|--|--|
| | |
| | |
| | |

| | |
|--|--|
| | |
| | |
| | |

| | |
|--|--|
| | |
| | |
| | |

| | |
|--|--|
| | |
| | |
| | |

6)

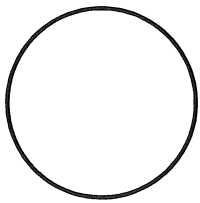

あおでぬりましょう

あ
お

| | |
|--|--|
| | |
| | |
| | |

あ お

| | |
|--|--|
| | |
| | |
| | |

4. どれですか

あし
●

いし
●

うし
●

いえ
●

え
●

あお
●

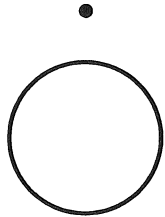

あおでぬりましょう

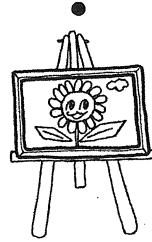

5. かきましよう

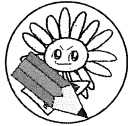

④

し

う

③

し

あ

②

い

え

①

し

い

お

あ

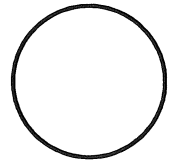
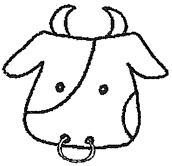

あおでぬりましょう

| |
|--|
| |
| |

| |
|--|
| |
| |

| |
|--|
| |
| |

| |
|--|
| |
| |

| |
|---|
| あ |
| お |

6. ききましょう かきましょう

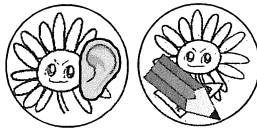

1)

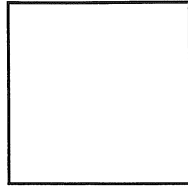
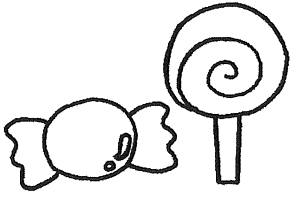

め

2)



か

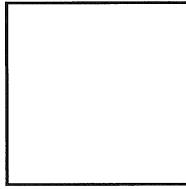

る

3)

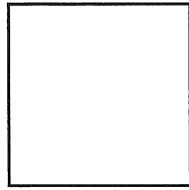
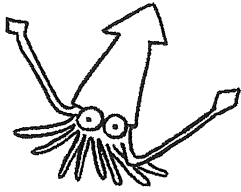

か

4)

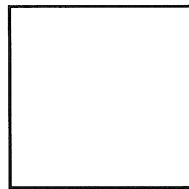
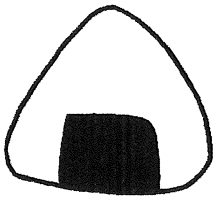

にぎり

5)

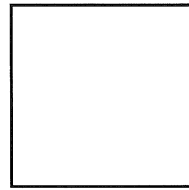
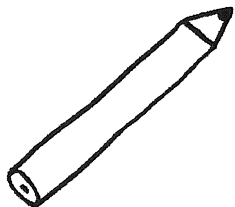

んぴつ

6)

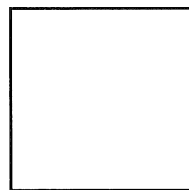
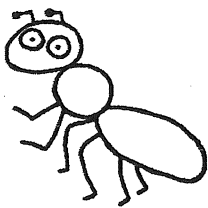

り

7)

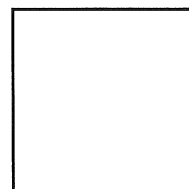

さぎ

8)

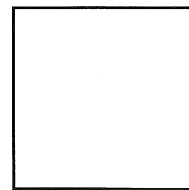
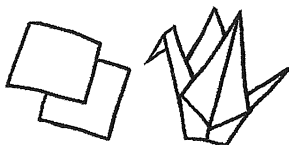

りがみ

3 か き く け こ

1. よみましょう 

1) か き く け こ

2) く か け こ き

3) か け き く け こ か こ

4) こ く け か き か く け き こ

2. よみましょう 

1) かお



2) き

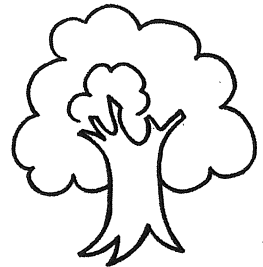

3) つき

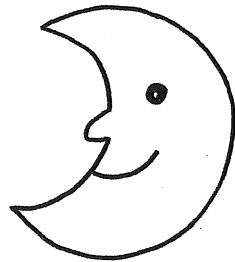

4) くつ



5) いけ

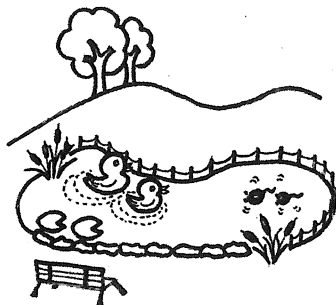

6) ここ

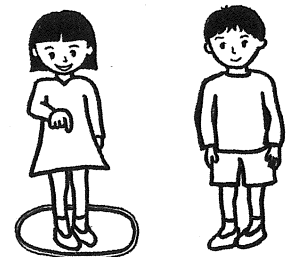

3. かきましょう



か
 かきくけこ

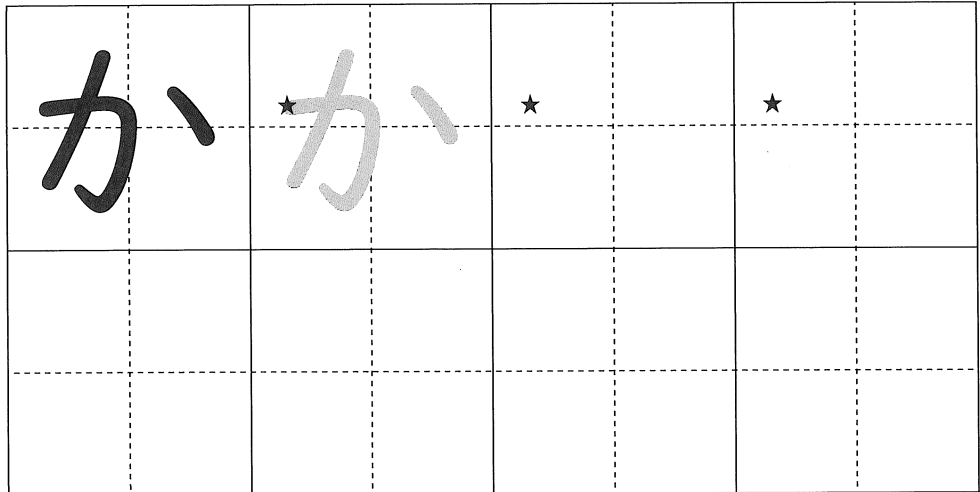
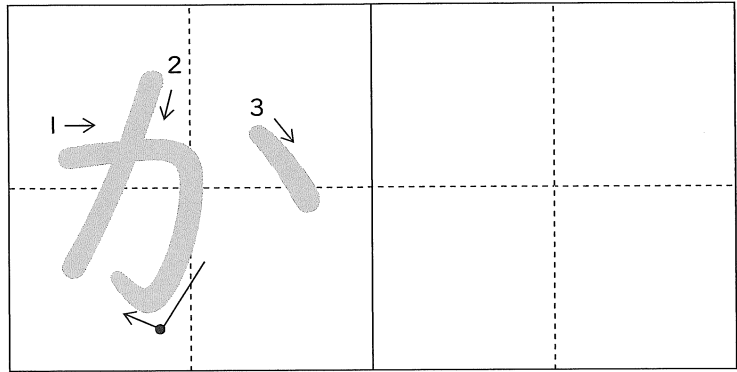

き
 かきくけこ

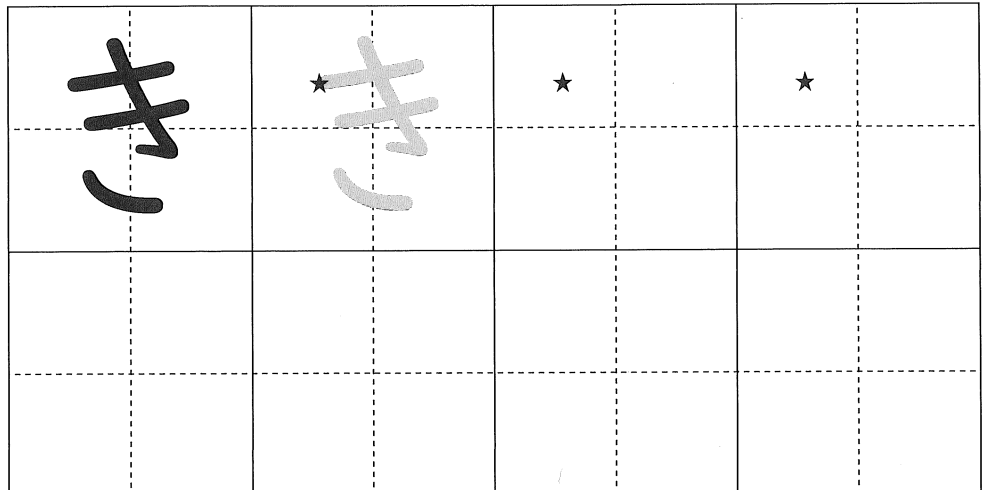
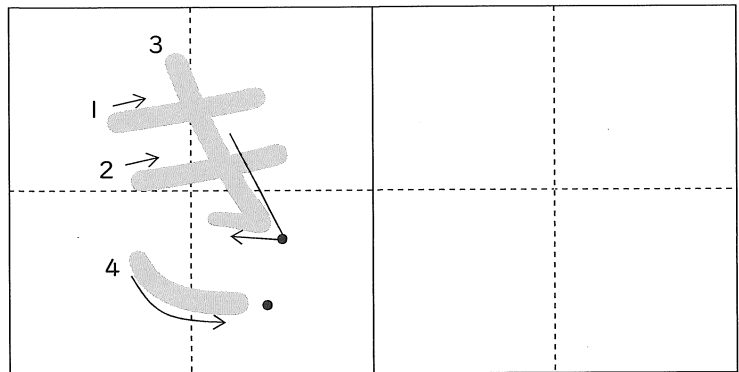

く

かき く けこ

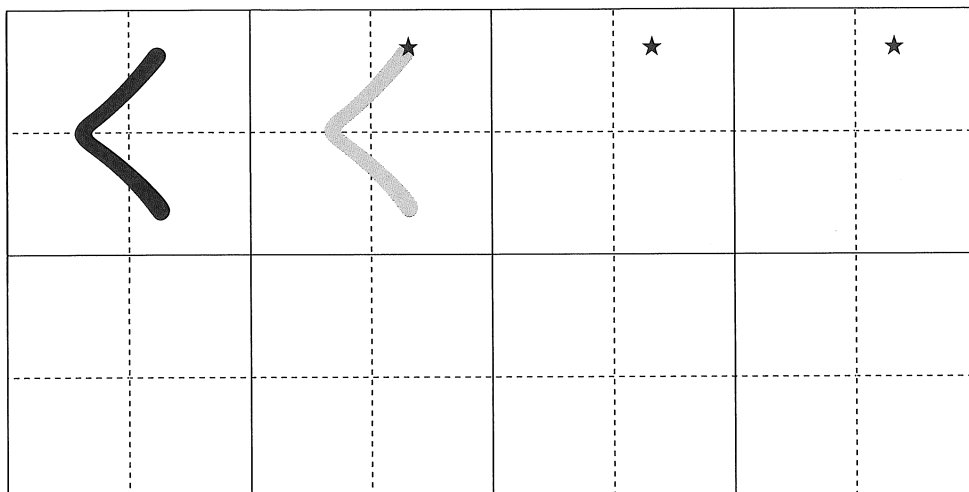
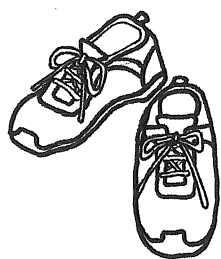
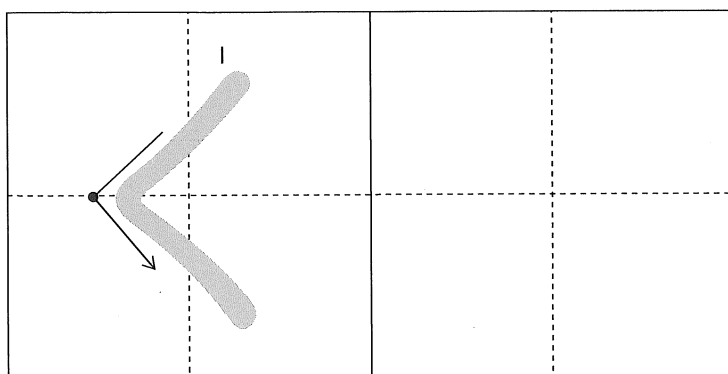

け

かきく け こ

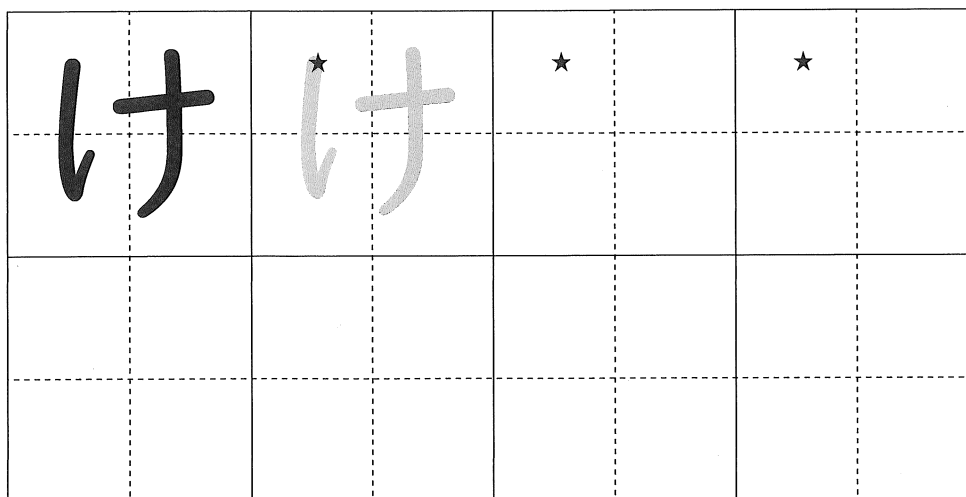
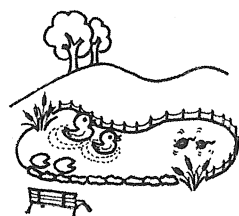
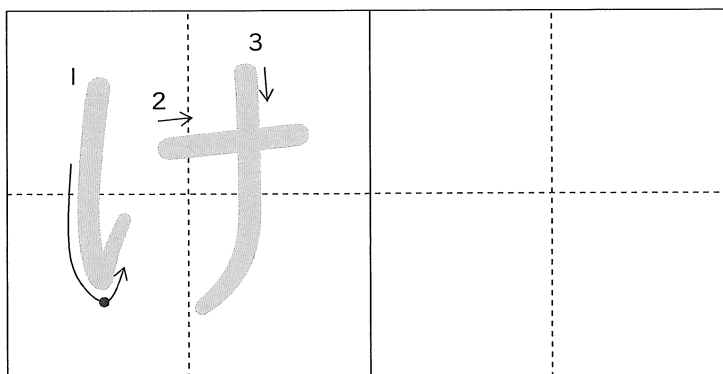

フ

シ

かきくけ㊦

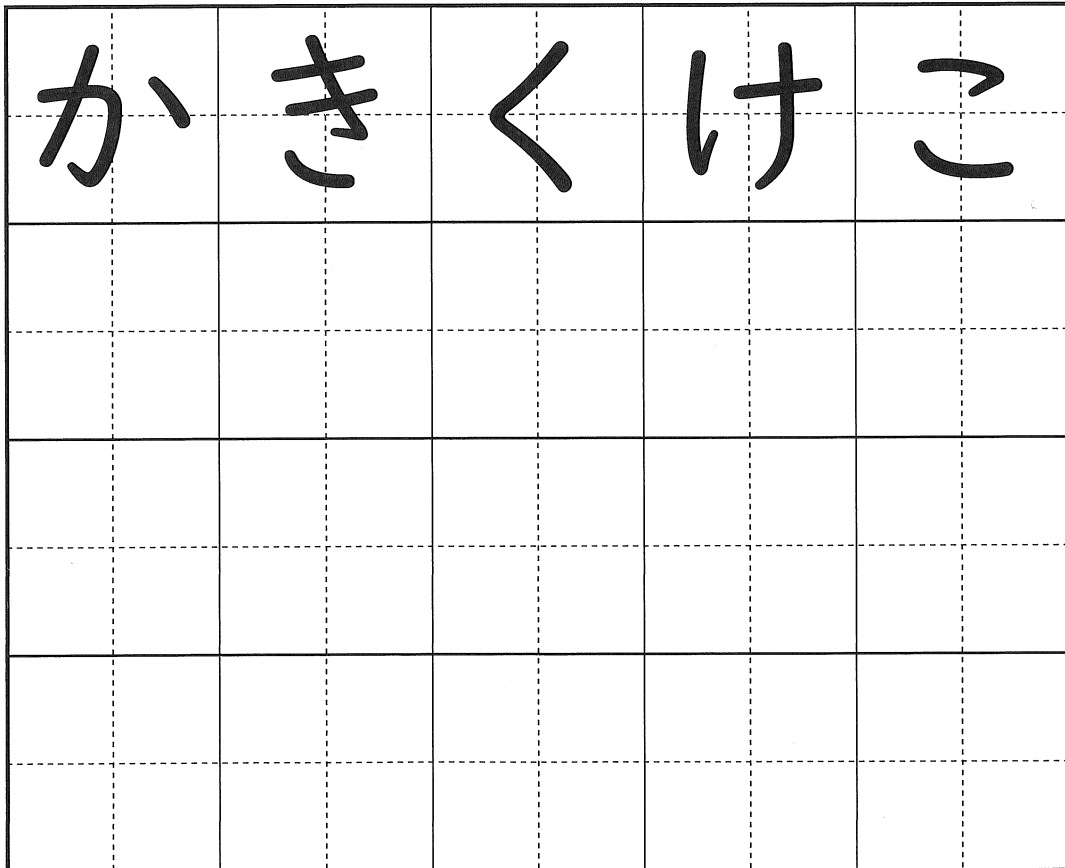
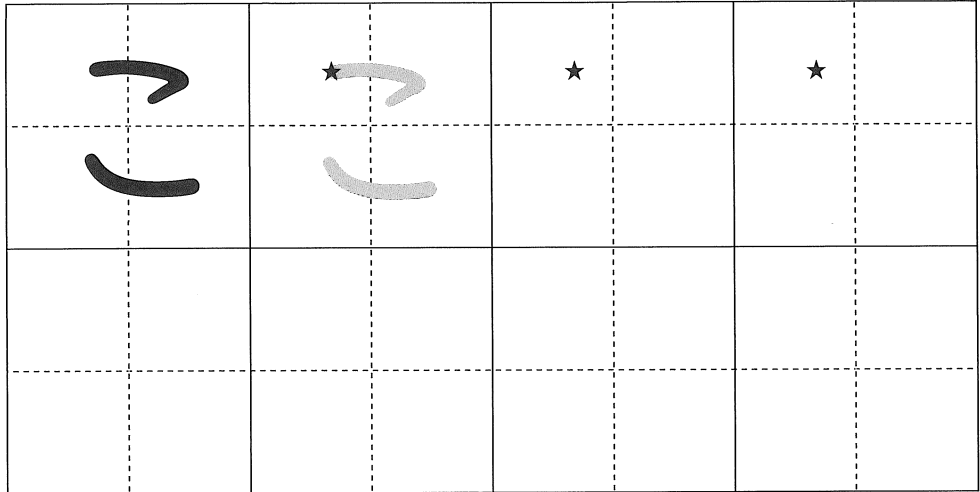
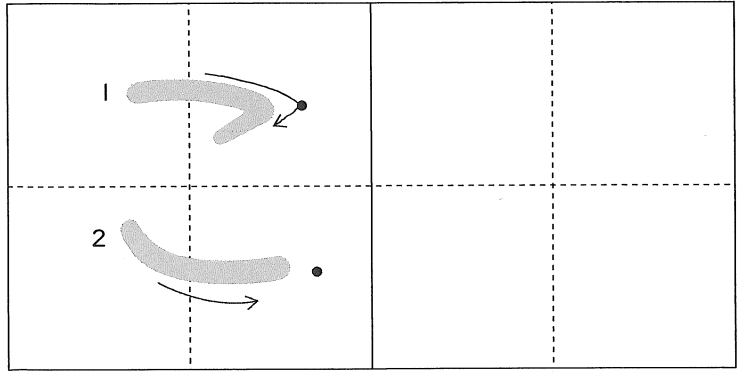

1)

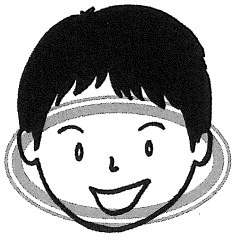

か
お

| | |
|--|--|
| | |
| | |
| | |
| | |

か お

| | |
|--|--|
| | |
| | |
| | |
| | |

2)



き

| | |
|--|--|
| | |
| | |
| | |
| | |

き

| | |
|--|--|
| | |
| | |
| | |
| | |

| | |
|--|--|
| | |
| | |
| | |
| | |

| | |
|--|--|
| | |
| | |
| | |
| | |

| | |
|--|--|
| | |
| | |
| | |
| | |

| | |
|--|--|
| | |
| | |
| | |
| | |

3)

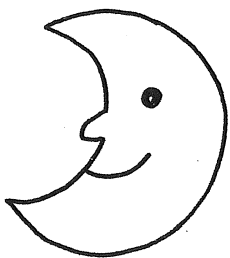

つ
き

| | |
|--|--|
| | |
| | |
| | |
| | |

つ き

| | |
|--|--|
| | |
| | |
| | |
| | |

4)



| |
|---|
| く |
| っ |

| |
|--|
| |
| |

| | |
|---|---|
| く | っ |
|---|---|

| | |
|--|--|
| | |
|--|--|

5)



| |
|---|
| い |
| け |

| |
|--|
| |
| |

| | |
|---|---|
| い | け |
|---|---|

| | |
|--|--|
| | |
|--|--|

6)

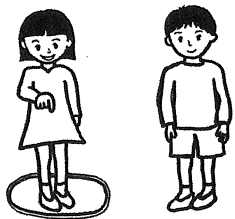

| |
|---|
| こ |
| こ |

| |
|--|
| |
| |

| | |
|---|---|
| こ | こ |
|---|---|

| | |
|--|--|
| | |
|--|--|

4. どれですか

き
●

いけ
●

かお
●

つき
●

ここ
●

くつ
●

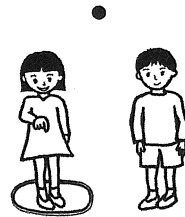
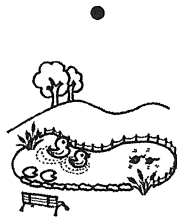

5. かきましよう



④
く

③
き

②
け

①
こ

お

つ

つ

い

こ

か

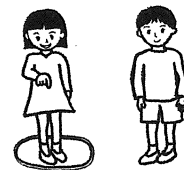

| |
|--|
| |
| |

| |
|--|
| |
| |

| |
|--|
| |
| |

| |
|--|
| |
| |

| |
|---|
| か |
| お |

6. ききましょう かきましょう

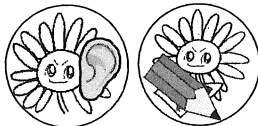

1)

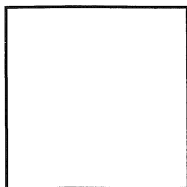
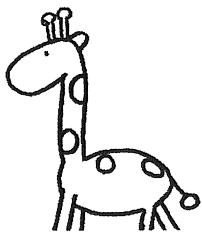

りん

2)

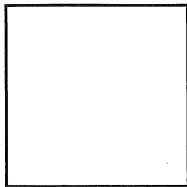
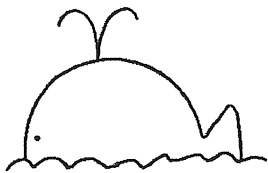

じら

3)

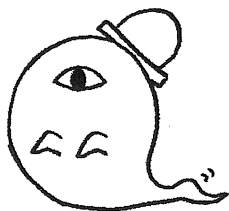

おば

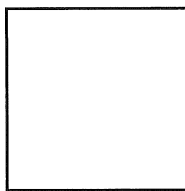

4)

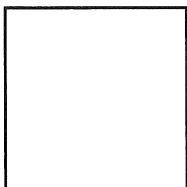
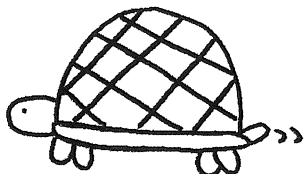

め

5)

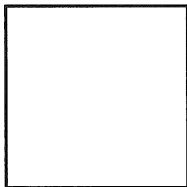

うえん

6)

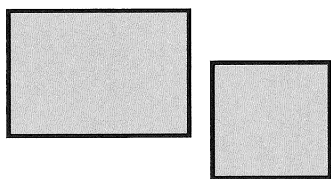

し

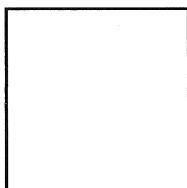

く

7)

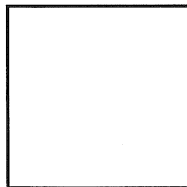

つね

8)

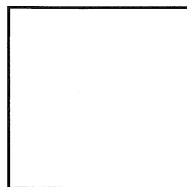
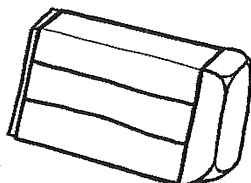

しごむ

4 さ し す せ そ

1. よみましょう 

1) さ し す せ そ

2) す さ せ そ し

3) さ せ し す せ そ さ そ

4) そ す せ さ し さ す せ し そ

2. よみましょう 

1) かさ



2) すし

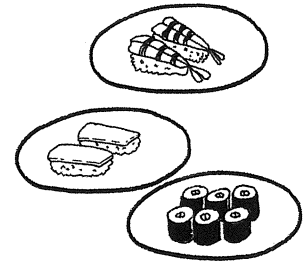

3) いす

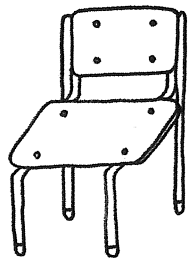

4) すいか

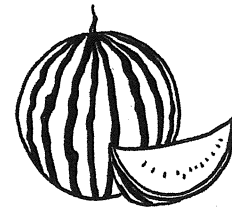

5) せき



6) あそこ

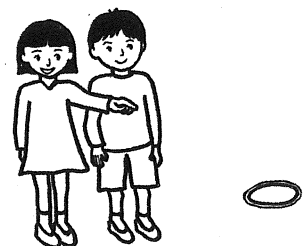

3. かきましよう



さ

し

さ し す せ そ

| | | |
|--|--|--|
| | | |
| | | |



| | | | |
|--|--|--|--|
| | | | |
| | | | |
| | | | |

し

さ し す せ そ

| | | |
|--|--|--|
| | | |
| | | |

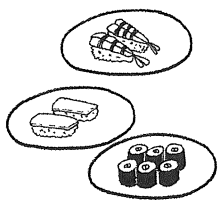

| | | | |
|--|--|--|--|
| | | | |
| | | | |
| | | | |

す
さしす(す)せそ

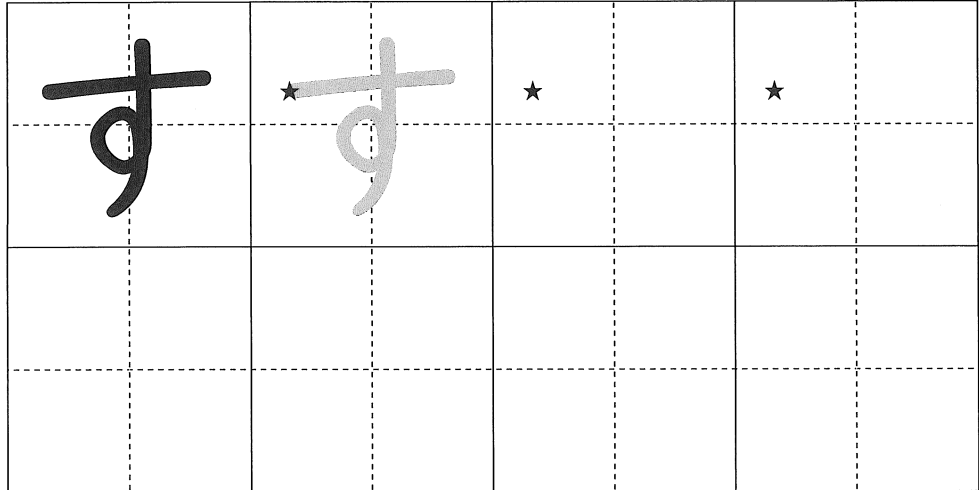
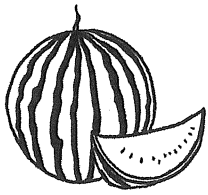
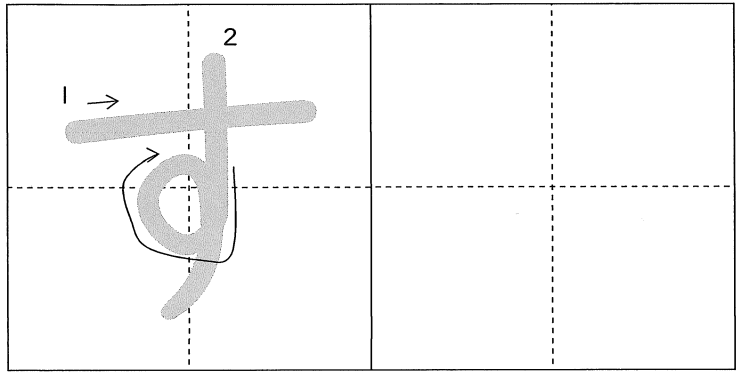

せ
さしす(せ)そ

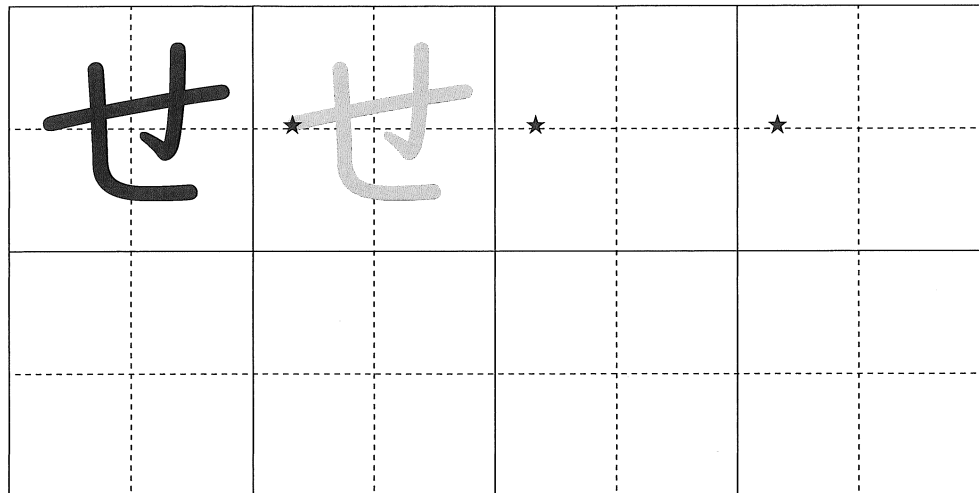
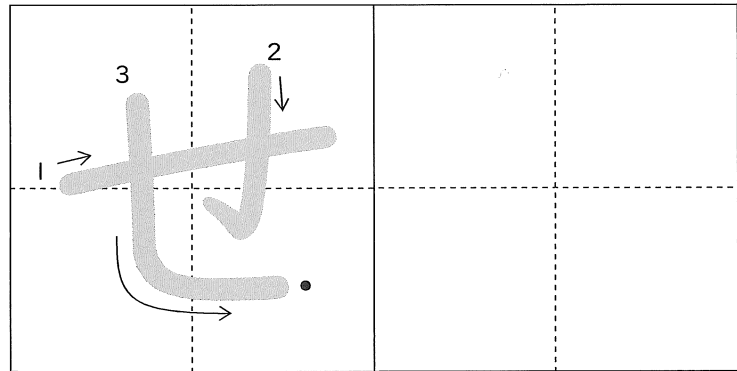

そ

さしすせ(そ)

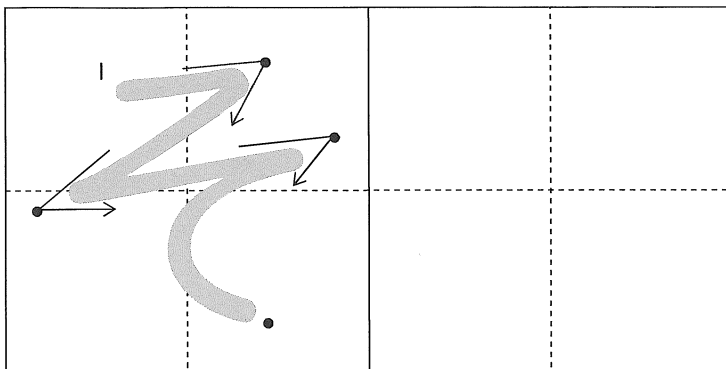

○

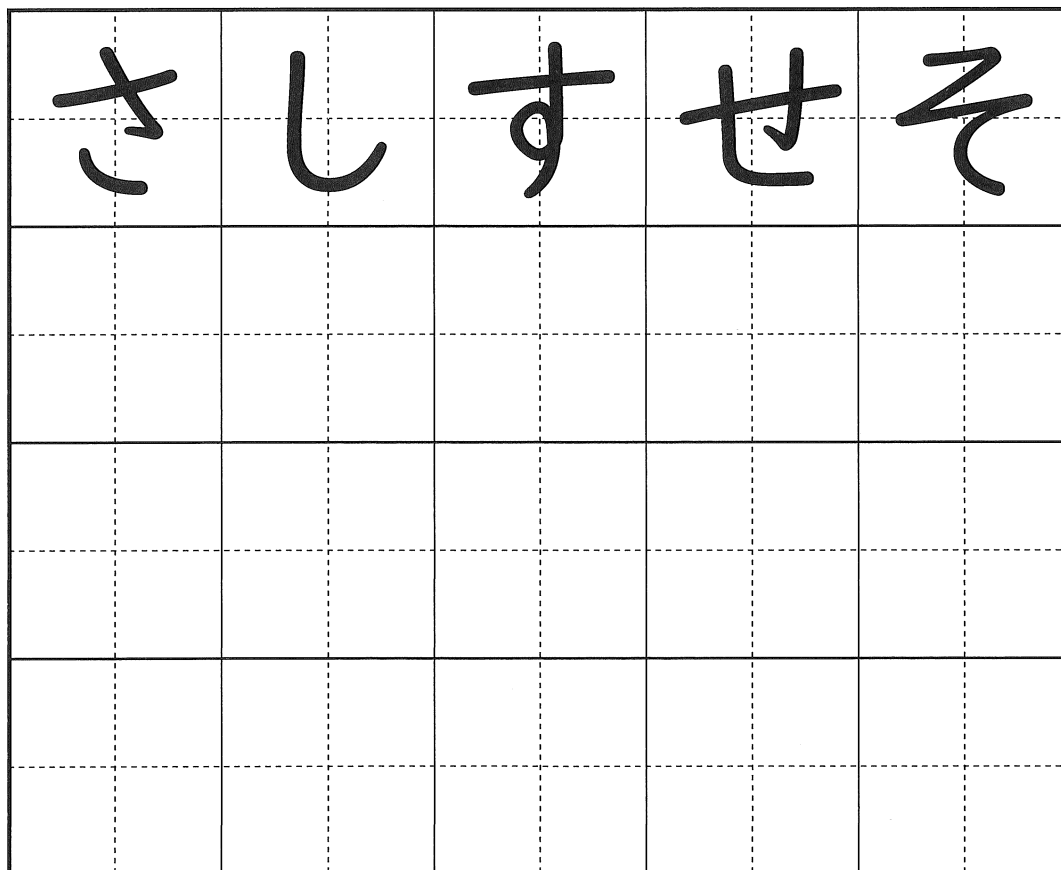
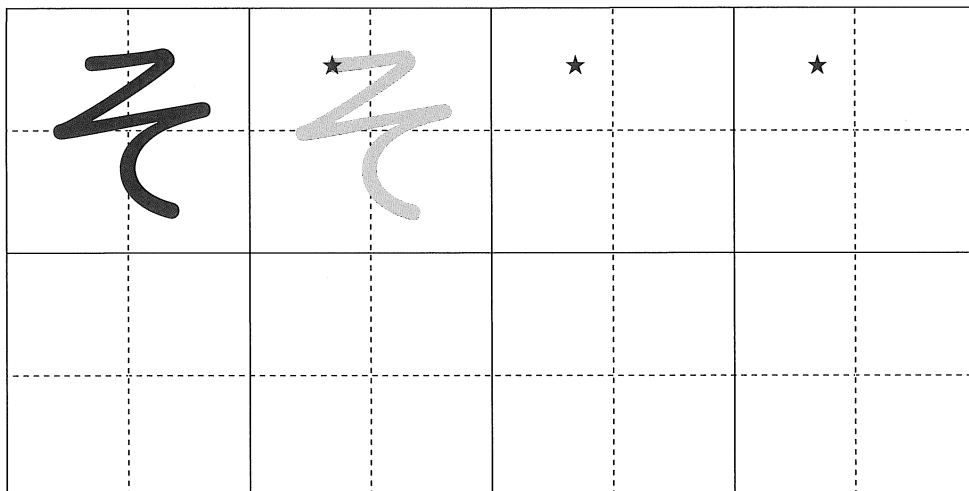

1)



か
さ

| | |
|--|--|
| | |
| | |
| | |
| | |

か さ

| | |
|--|--|
| | |
| | |
| | |
| | |

2)

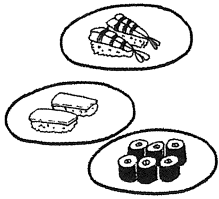

す
し

| | |
|--|--|
| | |
| | |
| | |
| | |

す し

| | |
|--|--|
| | |
| | |
| | |
| | |

3)

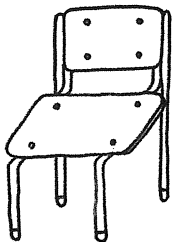

い
す

| | |
|--|--|
| | |
| | |
| | |
| | |

い す

| | |
|--|--|
| | |
| | |
| | |
| | |

4)



すい か

Blank handwriting practice box for the word 'すいか'.

す
い
か

Blank handwriting practice box for the word 'すいか'.

5)



せ
き

せ き

Blank handwriting practice box for the word 'せき'.

6)

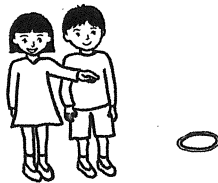

あ そ こ

Blank handwriting practice box for the word 'あそこ'.

あ
そ
こ

Blank handwriting practice box for the word 'あそこ'.

4. どれですか

せき

かさ

すし

すいか

あそこ

いす

●

●

●

●

●

●

●

●

●

●

●

●

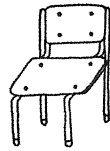
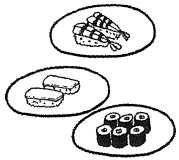

5. かきましよう



④

③

②

①

か

こ

し

き

す

す

あ

す

せ

い

い

そ

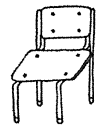
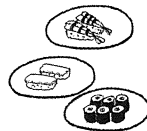



| |
|--|
| |
| |
| |

| |
|--|
| |
| |
| |

| |
|--|
| |
| |

| |
|--|
| |
| |

| |
|---|
| い |
| す |

6. ききましょう かきましょう  

1)

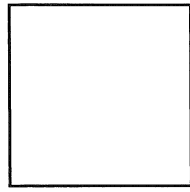
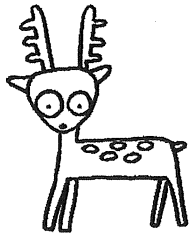

か

2)

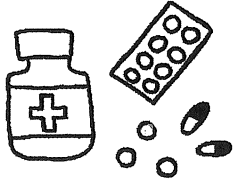

く

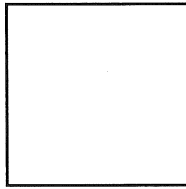

り

3)

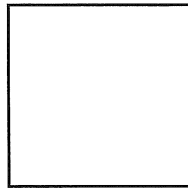

うじ

4)

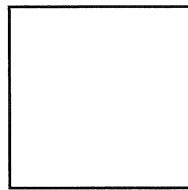
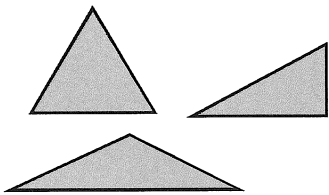

んかく

5)

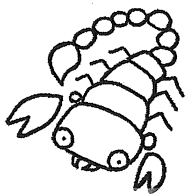

さ

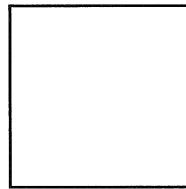

り

6)

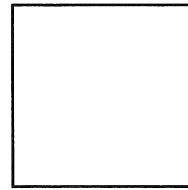
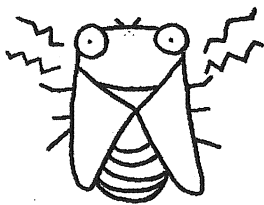

み

7)



り

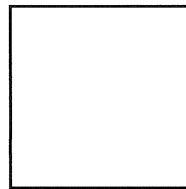

8)

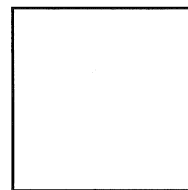
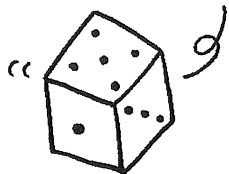

いころ

チェックシート① あ行～さ行

よみましょう

指導される方へ：文字やことばを児童に読ませ、
チェックしてください。

| | | チェック | | | | チェック | |
|---|---|------|-----|---|------|------|-----|
| | | 月 日 | 月 日 | | | 月 日 | 月 日 |
| ① | え | | | ⑪ | こ | | |
| ② | け | | | ⑫ | お | | |
| ③ | せ | | | ⑬ | く | | |
| ④ | き | | | ⑭ | う | | |
| ⑤ | い | | | ⑮ | す | | |
| ⑥ | し | | | ⑯ | かさ | | |
| ⑦ | さ | | | ⑰ | せき | | |
| ⑧ | か | | | ⑱ | すし | | |
| ⑨ | あ | | | ⑲ | くうき | | |
| ⑩ | そ | | | ⑳ | おいしい | | |

*** やってみましょう *****

「あいうえお」「かきくけこ」「さしすせそ」の もじの ところに すきないろを ぬりましょう。

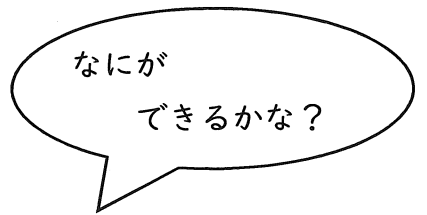
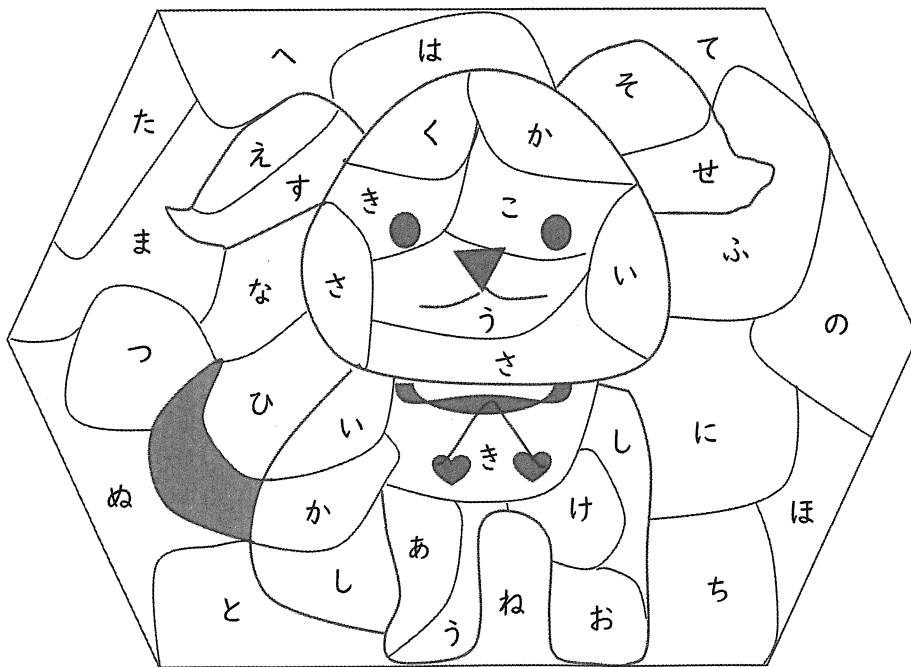

こたえ

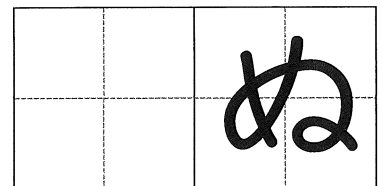

チェックシート① あ行～さ行

指導される方へ：前ページの「よみましょう」の中の文字やことばを選び、指導者が読んで児童に書かせてください。

きいて かきましょう

| | | | | | | | |
|---|--|---|--|---|--|---|--|
| ① | | ② | | ③ | | ④ | |
| ⑤ | | ⑥ | | ⑦ | | ⑧ | |
| ⑨ | | ⑩ | | ⑪ | | ⑫ | |
| ⑬ | | ⑭ | | ⑮ | | | |



【ひとやすみ①】

●と●、★と★、■と■ を
せんで つなぎましょう。

れい)

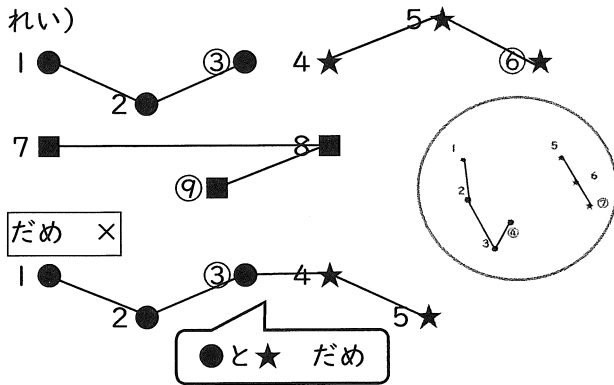

だめ ×

●と★ だめ

1)

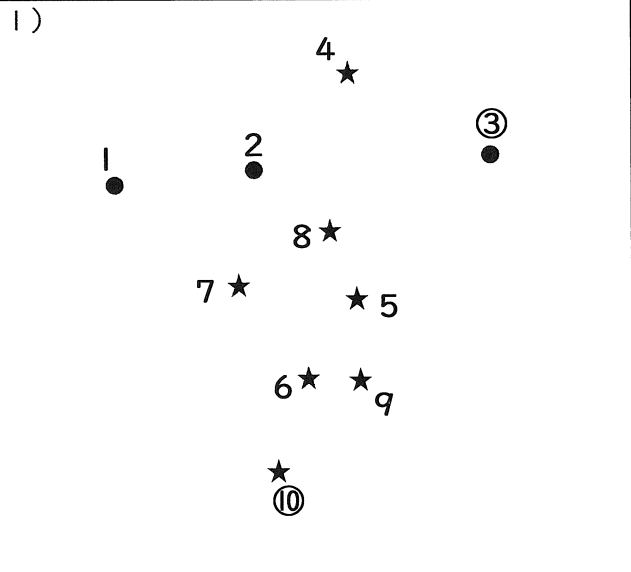

2)

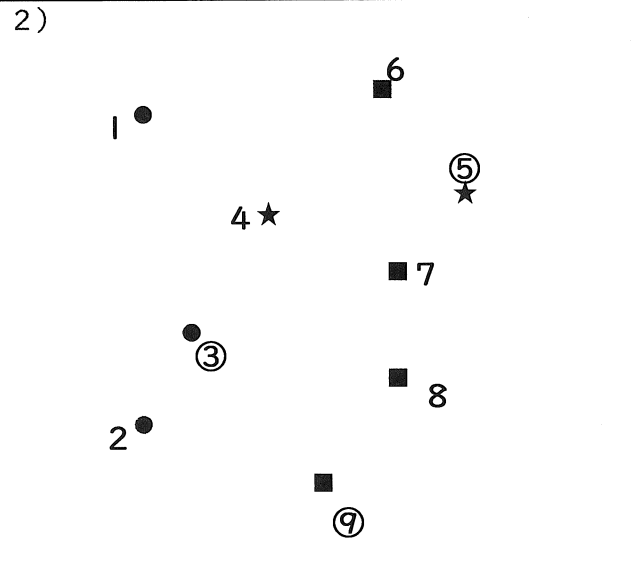

3)

